

ABB MEASUREMENT & ANALYTICS | DATA SHEET

ScreenMaster RVG200

Paperless recorder

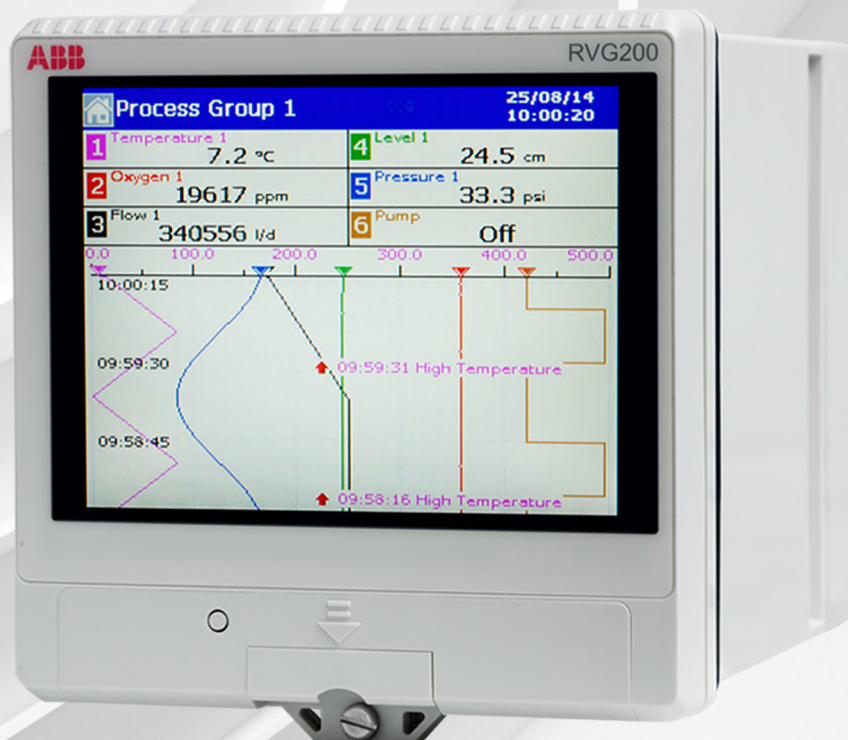

Measurement made easy

Process data at your fingertips

High security data recording

- protected data storage compliant to 21 CFR Part 11

Simple, intuitive operation

- touchscreen operation and configuration
- USB ports for keyboard and barcode scanner

Easy remote access

- **standard Ethernet communications provide timesaving remote access and operation via a standard web browser**

Complete data recording solution

- automatic data collection via Ethernet combined with powerful data analysis using DataManager Pro software

Built to survive

- IP66 and NEMA 4X environmental protection

Scalable high specification I/O

- high accuracy and stability compliant to AMS 2750 E
- recording of up to 24 channels

Problem solving advanced functionality

- math, logic, flow totalization, energy calculations and batch recording

Overview

The ScreenMaster RVG200 is a secure, easy-to-use paperless recorder. Up to 24 process signals can be connected directly to the RVG200's analog inputs or transferred to it via digital communications. All process data, including alarm conditions, math calculation results and totalizer values, are displayed clearly to the operator and archived securely in an encrypted format for review using the accompanying DataManager Pro PC software.

A touch screen featuring swipe gesture control provides fast and intuitive operation. USB ports further simplify operation by enabling peripherals (for example, a keyboard, mouse or barcode scanner) to be attached.

The RVG200's standard Ethernet communications and inbuilt web server enable:

- easy integration to an existing network
- automatic data collection
- remote process supervision

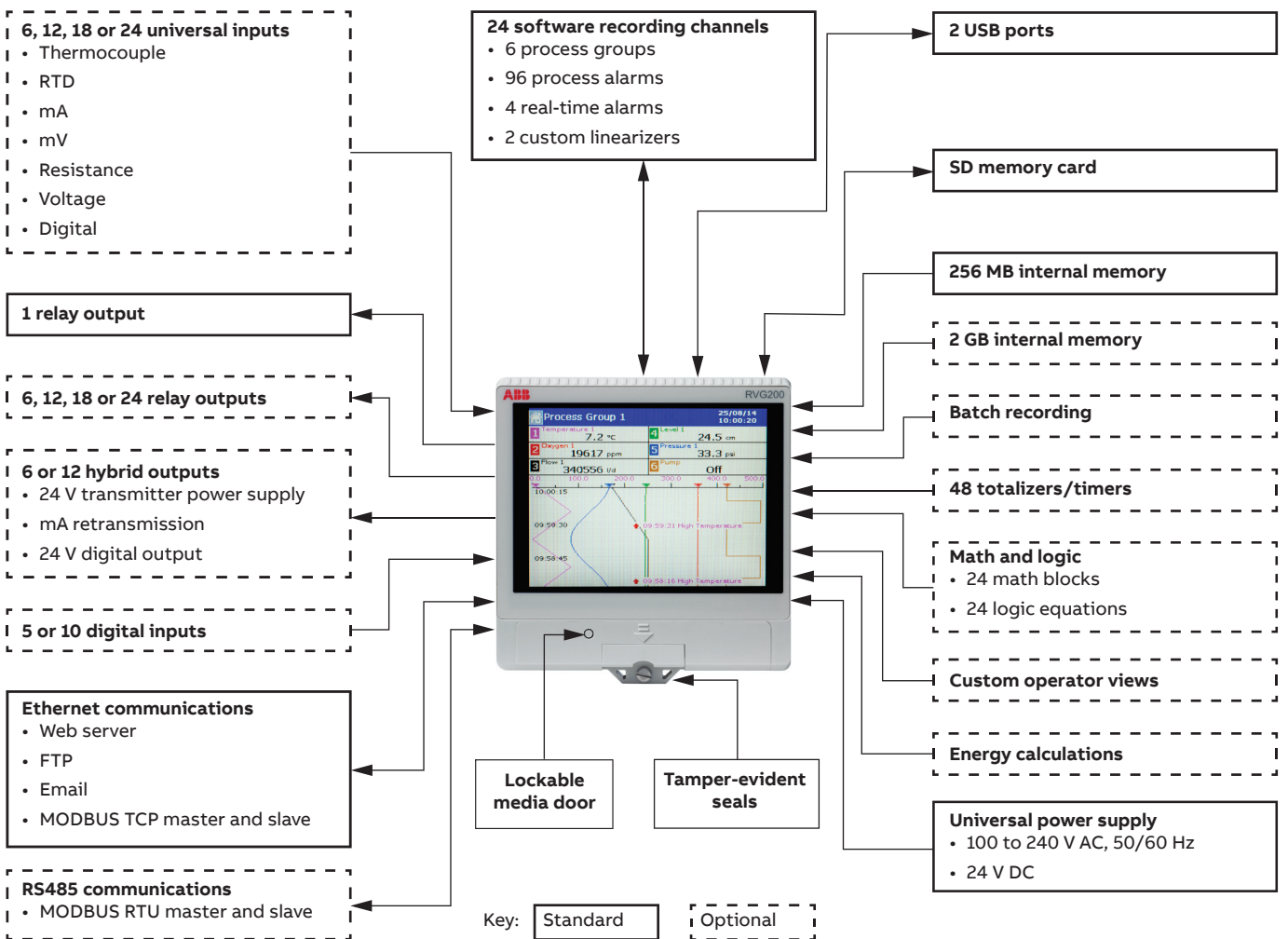

... Overview

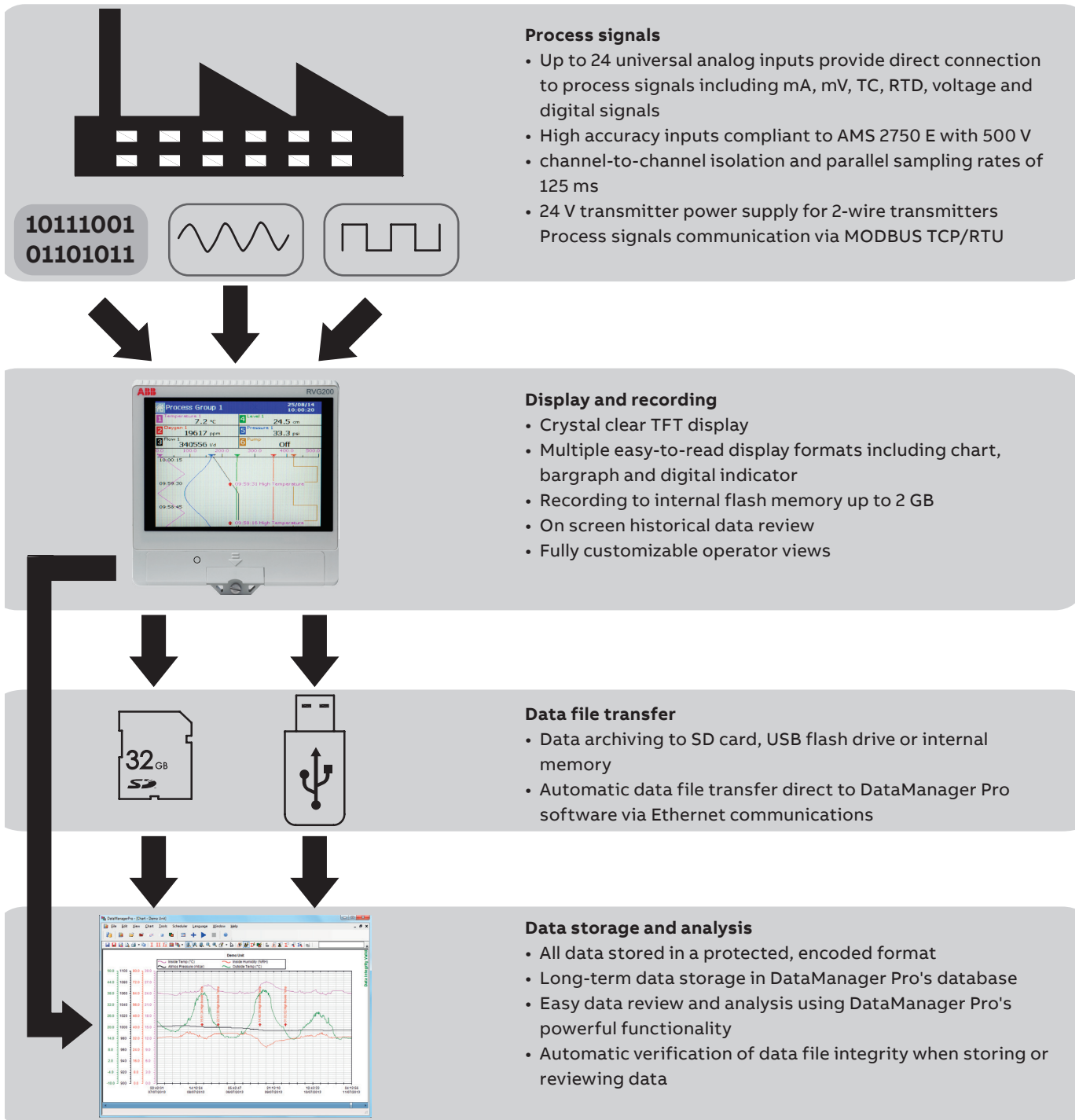

Display examples

To display process information clearly, the RVG200 features 6 configurable process groups. This enables signals from one process to be grouped by type or enables the RVG200 to monitor up to 6 separate processes. Each process group has its own set of displays including a chart, bargraph and digital indicator. Additionally, an overview display simultaneously shows all process signals being recorded

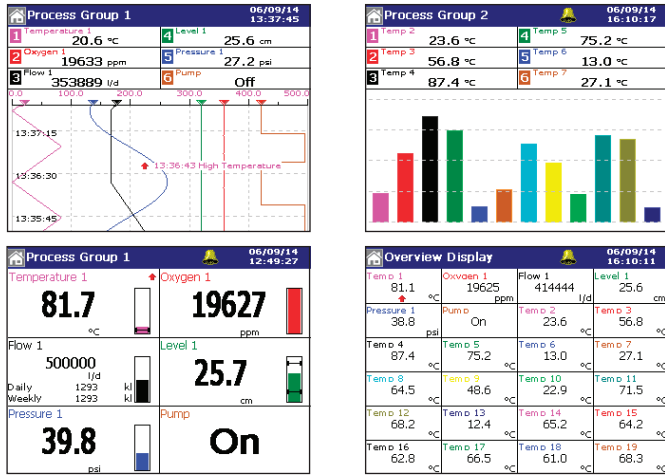

Figure 1 Chart, indicator, bargraph, and overview displays

User-customizable views

Optional user-customizable views enable the creation of basic plant mimics and custom operator views that indicate current process values and status formatted in exactly the way you want to see it. Custom views are created using a PC tool in which bmp images, text, numeric values and function buttons can be laid out and configured. A total of seven custom views can be loaded in to a single recorder, one per group with the seventh as an overview.

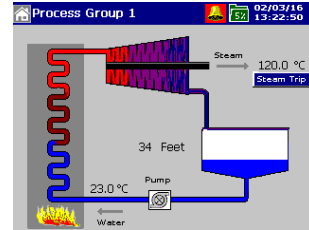

Figure 3 Custom view example

Easy operation

The RVG200's responsive touchscreen makes operation quick and simple. The intuitively structured operation and configuration menus can be navigated quickly via an icon-based system or the process groups and displays controlled via on-screen swipe gestures.

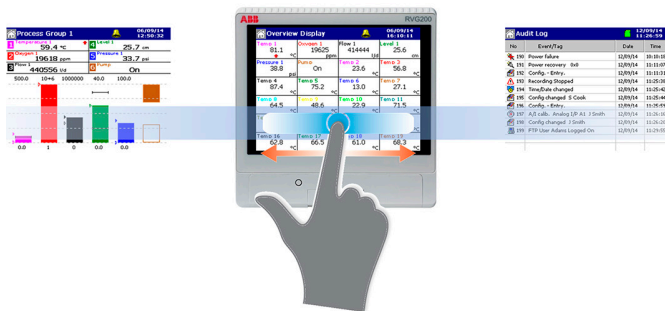

Figure 2 Navigation using on-screen swipe gestures

Ethernet integration



Easy integration



- 100 Mb Ethernet fitted as standard
- Static or automatic IP address configuration via DHCP

Web server



- Quick and easy remote supervision of both process and recorder
- Uses a standard web browser, smart phone or tablet– no special software required
- View an online demonstration at <http://217.46.239.73>

email

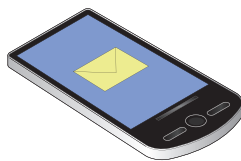

- Process alarm or critical process condition notification by email
- Scheduled process status reports by email

DataManager Pro software

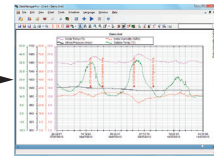

- Automatic scheduled data file collection from multiple recorders
- Time synchronization

MODBUS TCP



- Master (client) and slave (server) capability
- Communication of real-time data to/from recorder

Remote operation

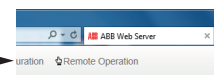

- Operate the recorder as if you were stood in front of it
- Acknowledge alarms, operate totalizers and change configurations
- Uses a standard web browser, smart phone or tablet – no special software required

Historical logs

Three historical logs are kept providing detailed alarm, totalizer and audit history.

Alarm event log

- a complete history of all alarm occurrences including state changes, acknowledgements and operator messages.

Totalizer log

- a convenient summary of totalizer readings including daily, weekly and monthly values.

Audit log

- time, date and ID stamped system data including notification of configuration changes, calibration adjustments and operator actions. The audit log provides detailed evidence of the recorder's integrity and the validity of recorded data.

Math and logic

Math and logic capabilities are available as an option, providing powerful problem solving capability. Bracket and nesting capability enable complex equations to be created, the results of which can be displayed on screen, trended and logged to the memory card. Functionality includes:

- Standard mathematical functions (for example, addition, subtraction, multiplication and division) enable signals to be compared and the comparison values recorded or averages of groups of signals to be calculated.
- Switch and high/low selection functions provide sensor redundancy capability with failure-driven automatic switching between sensors.
- Rolling and real-time average functions can be applied to noisy or erratic process signals providing clearer representation of process trends.

Batch recording

The batch recording option enables simple recording and reviewing of batch processes. When a batch is started it is tagged with a unique batch number, operator identification and 3 user-definable description fields. All information can be entered using the on-screen keyboard, a USB keyboard or a barcode scanner. RVG200 can accommodate multiple batches within single- or multiple-process groups simultaneously. Using DataManager Pro, batches can be recalled for review simply and quickly using the unique batch number or descriptive information entered at the time of its recording. Additional functionality provides the ability to search and sort batch records for an entire production facility in many ways; including by product type, operator and time and date of processing.

Figure 4 Batch recording configuration dialog

DataManager Pro off-line review and analysis software

The RVG200 combined with ABB's DataManager Pro software provides a complete data recording, analysis and long-term storage solution.

All process data and historical log archive files recorded by the RVG200 are compatible with DataManager Pro.

Features include:

- Database management of data files ensures simple, long-term storage and instant retrieval of historical data.
- The graphing capabilities provide powerful interrogation of process data.
- Validity checking of all data files during the storage and retrieval process ensures maximum data integrity.
- Automatic data file collection via Ethernet communications from multiple ScreenMaster recorders provides maintenance-free data file collection.

For further information on the capabilities of DataManager Pro software, refer to data sheet DS/RDM500-EN.

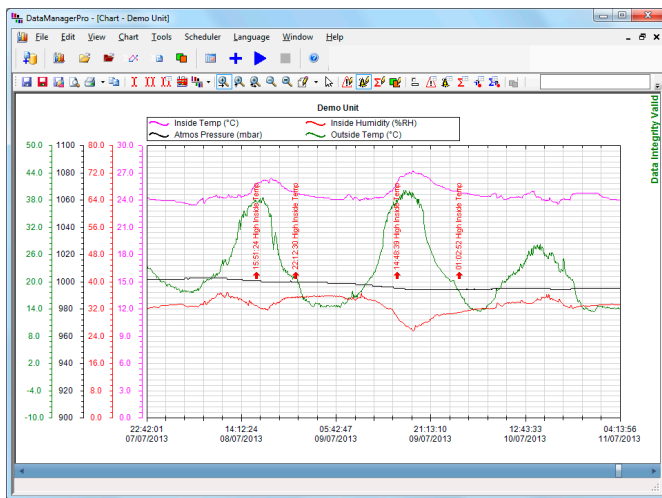

Figure 5 DM Pro screen shot

21 CFR part 11 compliance and GAMP validation package

With its comprehensive audit trail, protected archiving format and extensive physical and configuration security features, the ScreenMaster RVG200 is ideally suited to applications where compliance with 21CFR part 11 (the FDA's regulations regarding electronic record keeping) is required. For further information refer to INF13/147.

A template for validating the RVG200 paperless recorder is available. Following GAMP 5 (a risk-based approach to compliant GxP computerized systems), the template is designed to make the validation process as simple as possible and provides an IQ and OQ that is completed at the customer site, before and after installation. The RVG200's ability to automatically export a report of its configuration significantly speeds up the documentation process. Once completed, the template and report are then packaged together with other documentation relating to the system as a whole, ready to be presented to the governing regulatory body for inspection.

Energy calculations

The RVG200's energy calculations option provides the ability to accurately calculate heat energy in water and steam flows. Predefined equations for closed and return-less systems of water, saturated steam and superheated steam make setup quick and simple. The resultant mass, power and enthalpy values can then be trended and totalized as required. Note. The physical 'density' and 'enthalpy' values of steam and water are calculated in accordance with the latest version of industry standard IAPWS-IF 97.

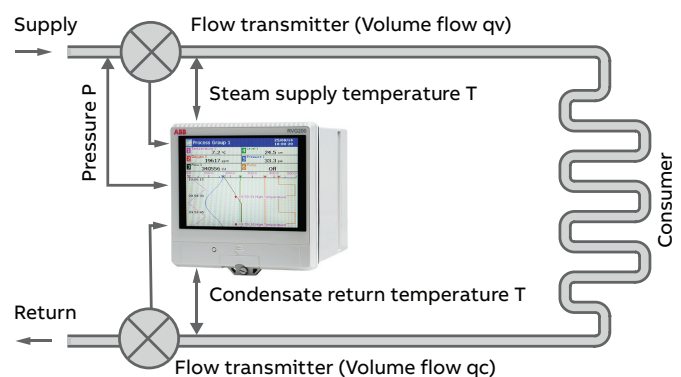
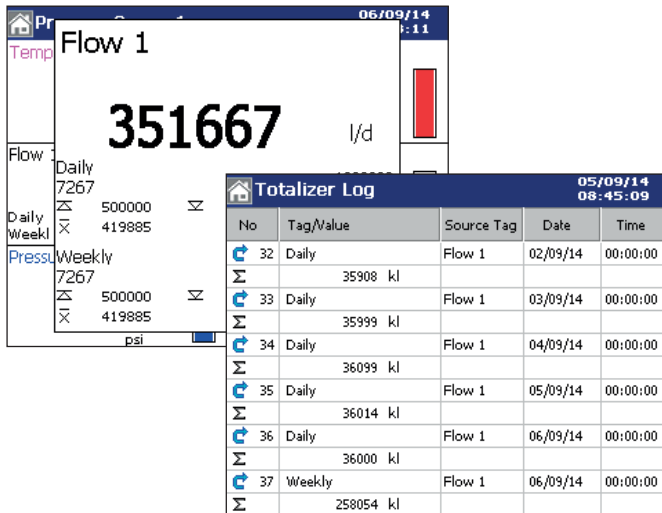

Figure 6 Steam power balance energy equation

Example applications/industries



Water and waste water monitoring

- Dual flow totalizers per channel provide the flexibility to record both a continuous and resettable total for a single flow signal. Both totalizers are clearly displayed to the operator together with the instantaneous flow rate.
- A totalizer log keeps a record of all totalizer occurrences; whenever a totalizer is started, stopped or reset it is logged; together with the totalizer value at the time of the occurrence. The totalizer log is archived with other process data and can be reviewed using DataManager Pro software.
- Flow totalizers can be configured easily to reset automatically at specific intervals – for example, daily, weekly or monthly. When reset, the totalizer value is recorded in the totalizer log to provide a convenient history of flow totalizer values.
- When monitoring flow totals that must conform to strict limits, (for example, waste water discharge monitoring), the recorder's alarms can be configured to warn that a limit is approaching or has been reached.
- All process data can be accessed remotely using Ethernet communications. Additionally, the recorder's internal webserver, detailing the process status, can be viewed using a PC, tablet or smart phone and the flow totalizers can be remotely started, stopped and reset via the webserver.

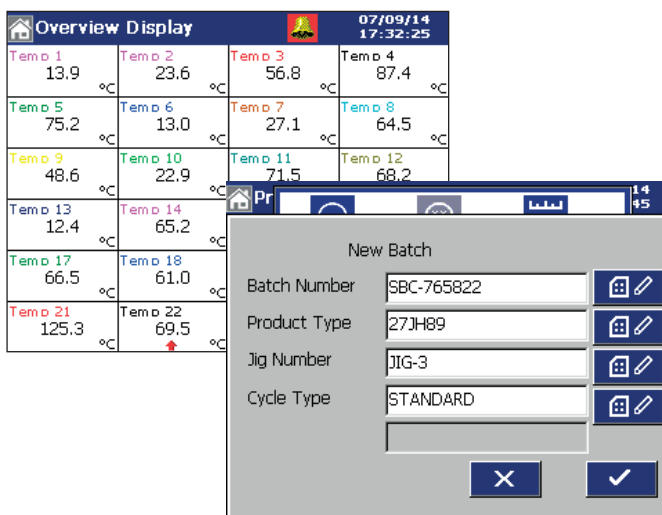

Heat treatment recording

- High specification inputs provide the accuracy and stability needed to meet the requirements of AMS 2750 E.
- Batch recording enables data such as batch number, product type and other identification to be tagged to process data. Specific batch records can be recalled rapidly and reviewed using DataManager Pro software.
- A barcode scanner can be connected to the front or rear USB port to prevent typographical errors that can occur when batch data is entered manually.
- Process signals can be recorded against a logarithmic scale enabling signals such as vacuum measurements to be represented accurately.
- Chart, digital indicator and bargraph display options enable operators to view process signals in their preferred format. Up to 24 signals can be displayed on a single screen enabling easy comparison of multiple measurements.
- Simple calibration procedure with traceable history detailed in the audit log.

... Example applications/industries

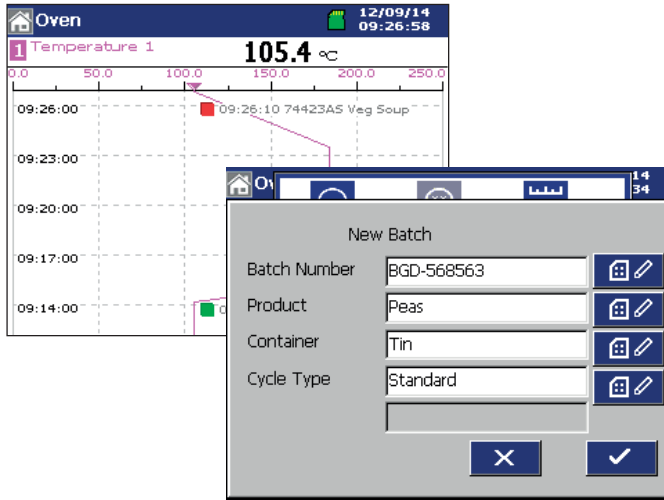

Food & Beverage process monitoring

- Full IP66 and NEMA 4X front face protection provide suitability for installation in hose-down environments and those subject to high levels of moisture. This enables installation next to the process, providing local operators with the information they need at their fingertips.
- Batch recording enables data such as batch number, product type and other identification to be tagged to process data. Specific batch records can be recalled rapidly and reviewed using DataManager Pro software.
- A barcode scanner can be connected to the front or rear USB port to prevent typographical errors that can occur when batch data is entered manually.
- F0 value calculation accounts for the time a cooking or sterilization process spends at, below and above its specified temperature. F0 value calculation not only ensures accurate processing of a product, it can also help to increase efficiency by reducing overall processing time.
- Chart, digital indicator and bargraph display options enable operators to view process signals in their preferred format. 6 process groups enable multiple processes to be monitored by a single recorder; each process has its own group to minimize confusion.

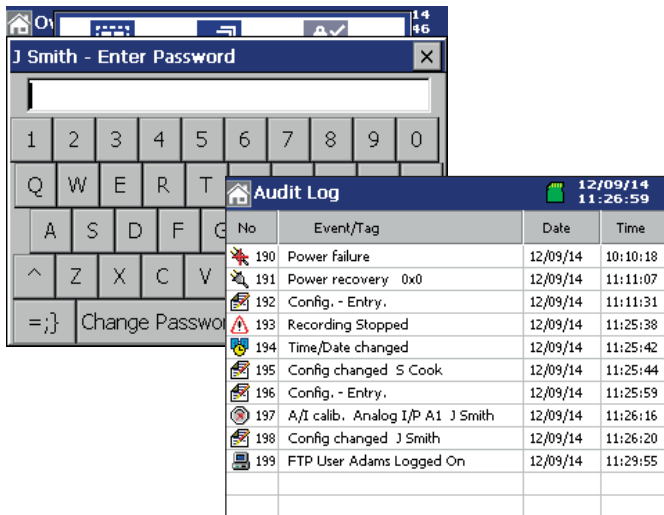

Pharmaceutical process monitoring

- Extensive security features including protected data files, multi-user password protection and automatic audit trail generation ensures compliance with 21 CFR part 11 requirements.
- Batch recording enables data such as batch number, product type and other identification to be tagged to process data. Specific batch records can be rapidly recalled and reviewed using DataManager Pro software.
- A barcode scanner can be connected to the front or rear USB ports to prevent typographical errors that can occur when batch data is entered manually.
- F0 value calculation accounts for the time a sterilization process spends at, below and above its specified temperature. F0 value calculation not only ensures accurate sterilization, it can also help to increase efficiency by reducing overall processing time.
- Any event relevant to data security is captured by the Audit Log. This includes configuration and calibration changes complete with time, date and where relevant operator identification. The audit log provides comprehensive evidence of the integrity of the recorder creating data files.

Specification

Operation and configuration

Configuration

- Via resistive touch screen or PC configuration
- Multiple configuration files can be stored in internal memory (up to 16 files) or external memory (SD card, USB flash drive)

Display

- Color, TFT, liquid crystal display (LCD) with LED backlight and brightness adjustment
- 144 mm (5.7 in.) diagonal display area, 76800 pixel (¾ VGA) display *

Language

English, German, French, Italian, Spanish, Chinese, Portuguese, Dutch, Turkish, Russian

Chart screen intervals

Selectable from 18 seconds to 7 days

Chart divisions

Programmable for up to 10 major and 10 minor divisions

Chart annotation

Alarm, batch, electronic signatures and operator messages may be annotated on the chart

Real time clock

Accuracy:

- ± 5 ppm (± 0.43 seconds per day)

Back-up battery:

- Battery low warning
- Provides 3 years support for unpowered condition
- 10 year shelf-life

Security

Physical

- Lockable media door
- Front and rear tamper-evident seals

Configuration security

Password protection:

- Access to configuration is enabled only after the user has entered a password

Internal switch protection:

- Access to configuration is enabled only after a hardware switch has been set. This switch is situated behind a tamper-evident seal

Logging security

Configuration:

- Can be configured for password protection or free access to logging level

Basic type security

4 individual users with unique user name and passwords

Advanced type security

Number of users:

- Up to 40

User names*:

- Up to 20 characters

Access privileges:

- Logging access – Yes/No
- Configuration access – none/load file only/limited/full

Passwords:

- Up to 20 characters
- A minimum required password length of 4 to 20 characters can be configured and a password expiry time can be applied to eliminate password ageing

Password failure limit:

- Configurable for 1 to 10 consecutive occasions or 'infinite'
- A user is deactivated if a wrong password is entered repeatedly

Deactivation of inactive users:

- Can be disabled or configured for 7, 14, 30, 60, 90, 180 or 360 days of inactivity
- Users are deactivated (by removal of access privileges) after a period of inactivity

* A small percentage of the display pixels may be either constantly active or inactive. Maximum percentage of inoperative pixels < 0.01 %

* User names are unique (names cannot be repeated)

... Specification

Operator views

Contents	Views available			
	Chart	Bargraph	Digital indicator	Custom
Instantaneous values/ states	✓	✓	✓	✓
Units of measure	✓	✓	✓	✓
Channel tags	✓	✓	✓	✓
Alarm status	✓	✓	✓	✓
Alarm trip markers	—	✓	✓	—
Max./Min. markers	—	✓	✓	—
Analog bargraphs	—	✓	✓	—
Totalizer values & units of measure	—	—	✓	✓
Totalizer tags	—	—	✓	✓
Maximum, minimum and average batch values	—	—	✓	✓
Graphical view of historical data	✓	—	—	—

* If Totalizer option is fitted and selected

Standard functionality

Operator messages

- Number:
- 24

Trigger

Via front panel or digital signals

Recording in alarm/event log

Can be enabled or disabled on configuration

Chart signatures

Recorded in the alarm/event log,
complete with operator identification

Process alarms

- Number
- 96 (4 per recording channel)

Types

- High/Low:
- Process
 - Latch
 - Annunciator
- Rate:
- Fast/slow

Tag

20-character tag for each alarm

Hysteresis

Programmable value and time hysteresis
(1 to 9999 seconds)

Alarm enable

Allows alarm to be enabled/disabled via a digital input

Alarm log enable

Recording of alarm state changes in the alarm/event log
can be enabled/disabled for each alarm

Acknowledgement

Via front panel or digital signals

Real-time alarms

- Number:
- 4

Programmable

Day of the week, 1st of month, start and duration times

Custom linearization

- Number:
- 2

Number of breakpoints

20 per linearizer

Recording to internal memory

Internal flash memory

- 256 MB flash memory upgradeable to 2 GB
- Oldest data is automatically overwritten by new data when memory is full

Data integrity checks

Checksum for each block of data samples

Independent process groups

6 (maximum of 24 channels per group)

Number of recording channels

24 (each channel can be assigned to 1 group only) *

Sources

Any analog or digital signal (for example, process input,
communications, math block and totalizer)

Filters

- Programmable for each channel to allow recording of:
- Instantaneous values
 - Average
 - Maximum, minimum
 - Maximum and minimum value over sample time

Primary/Secondary sample rates

Programmable from 0.125 seconds to 60 minutes for each
process group

Primary/Secondary sample rate selection

Via any digital signal or from password protected menu

Recording start/stop control

Via any digital signal

* If required, a single process input can be assigned to multiple recording channels enabling it to be visible in more than one process group.

Recording duration to 256 MB internal flash memory

Approximate duration calculated for continuous recording of 6 channels of analog data (for example, for 12 channels divide by 2, for 24 channels divide by 4).

Sample rate	Duration
0.125 seconds	10 days
1 second	80 days
10 seconds	2.2 years
60 seconds	13 years
10 minutes	130 years
60 minutes	960 years

Recording duration to 2 GB internal flash memory

Approximate duration calculated for continuous recording of 24 channels of analog data (for example, for 12 channels multiply by 2, for 6 channels multiply by 4).

Sample rate	Duration
0.125 seconds	20 days
1 second	160 days
10 seconds	4.4 years
60 seconds	26 years
10 minutes	260 years
60 minutes	1920 years

Historical logs

Types

Alarm/event, totalizer and audit logs

Number of records in each historical log

- Up to 500 in internal memory
- Oldest data is automatically overwritten by new data when log is full

Log entry events	Alarm/event log		Totalizer log		Audit log	
	• Alarm state changes • Operator messages		• User defined logging intervals • Totalizer stop/start, reset, wrap • Power up/down		• Configuration/calibration changes • System events • Errors, operator actions	
Information recorded in log/on screen	In log	On screen	In log	On screen	In log	On screen
Date & time of event	✓	✓	✓	✓	✓	✓
Type of event	✓	✓	✓	✓	✓	✓
Source tag	✓	—	✓	—	—	—
Alarm trip value & units of measure	✓	—	—	—	—	—
Alarm state	✓	✓	—	—	—	—
Alarm acknowledgement state	✓	✓	—	—	—	—
Operator ID	✓	—	—	—	✓	✓
Description	—	—	—	—	✓	✓
Batch total and units of measurement*	—	—	✓	✓	—	—
Maximum, minimum and average values plus units *	—	—	✓	✓	—	—
Secure total	—	—	✓	—	—	—

* If Totalizer option fitted and selected

... Specification

Archiving to removable media

Data that can be saved to removable media

- Recorded data per channel (1 to 24)
- Alarm event log data
- Totalizer log data
- Audit log data
- Configuration

File structure

Binary encoded

File protection

Protected binary format with data integrity checks

New file generation interval

Automatic

Archive sample rates

Data is archived at the same sample rate at which it is stored internally

Filename

20-character tag, prefixed with date/time

Data verification

Carried out automatically on all writes to removable-media files

SD card size

Cards up to 32 GB capacity may be used

USB flash drive size

Drives up to 32 GB capacity may be used

Archive media compatibility

ABB recorders comply with approved industry standards for SD cards and USB flash drives. ABB fully tests the brands of SD cards and USB flash drives that it supplies. Other brands may not be fully compatible with this device and therefore may not function correctly.

Recording duration

Approximate duration calculated for continuous recording of 6 channels of analog data (for example, for 12 channels divide by 2, for 3 channels multiply by 2).

Sample rate	Duration	
	512 MB SD card	1 GB SD card
1 seconds	8 months	16 months
10 seconds	6 years	13 years
40 seconds	26 years	51 years
60 seconds	40 years	75 years
120 seconds	80 years	255 years
480 seconds	315 years	620 years

Analog input modules

General

Number of process inputs

6 per module, maximum of 24 inputs

Input types

mA, mV, voltage, resistance, thermocouple, RTD, digital volt-free, digital 24 V

Thermocouple types

B, C, D, E, J, K, L, N, R, S, T

Resistance thermometer

PT100, PT1000, Ni120, Ni1000

Other linearizations

\sqrt{x} , $x^{3/2}$, $x^{5/2}$, custom linearization

Digital filter

Programmable 0 to 60 seconds

Display range

-999999 to 9999999

Common mode noise rejection

>120 dB at 50/60 Hz with 300 Ω imbalance resistance

Normal (series) mode noise rejection

>60 dB at 50/60 Hz

CJC rejection ratio

- ± 0.05 °C / °C
- CJC error 0.5 °C maximum with recorder @ 25 °C

Sensor break protection

Programmable as upscale or downscale

Temperature stability

0.02 %/°C or 2 μ V/°C (non-thermocouple ranges only)

AMS 2750 E

Subject to suitable field calibration, meets the requirements of 'Control, Monitoring and Recording Instruments' and 'Field Test Instruments'

Analog to digital converter resolution

24 bit

Long term drift

<0.1 % of reading or 10 μ V annually

Input impedance

- >10 M Ω (mV inputs)
- >900 k Ω (voltage inputs)
- 10 Ω (mA inputs)

Inputs

Linear inputs	Standard analog input	Accuracy (% of reading)
Millivolts	-150 to 150 mV	0.1 % or $\pm 20 \mu\text{V}$
Milliamperes	-50 to 50 mA	0.1 % or $\pm 10 \mu\text{A}$
Volts	-10 to 24 V	0.1 % or $\pm 10 \text{ mV}$
Resistance Ω (low)	0 to 550 Ω	0.1 % or $\pm 0.5 \Omega$
Resistance Ω (high)	0 to 10000 Ω	0.1 % or $\pm 5 \Omega$
Sample interval	125 ms per sample (all inputs are processed in parallel)	
Channel-to-channel input isolation	Galvanically isolated to 500 V DC	
Isolation from rest of recorder	Galvanically isolated to 500 V DC	

The figures in the following table include linearizer and electrical errors

Thermocouple	Maximum range		Measurement accuracy (% of reading)
	$^{\circ}\text{C}$	$^{\circ}\text{F}$	
B	250 to 1800	482 to 3272	0.1 % or $\pm 1 \text{ }^{\circ}\text{C}$ (1.8 $^{\circ}\text{F}$)
C	0 to 2300	32 to 4172	0.1 % or $\pm 0.5 \text{ }^{\circ}\text{C}$ (0.9 $^{\circ}\text{F}$)
D	0 to 2310	32 to 4190	0.1 % or $\pm 1.5 \text{ }^{\circ}\text{C}$ (2.7 $^{\circ}\text{F}$)
E	-100 to 900	-148 to 1652	0.1 % or $\pm 0.3 \text{ }^{\circ}\text{C}$ (0.54 $^{\circ}\text{F}$)
J	-100 to 900	-148 to 1652	0.1 % or $\pm 0.3 \text{ }^{\circ}\text{C}$ (0.54 $^{\circ}\text{F}$)
K	-100 to 1300	-148 to 2372	0.1 % or $\pm 0.3 \text{ }^{\circ}\text{C}$ (0.54 $^{\circ}\text{F}$)
L	-100 to 900	-148 to 1652	0.1 % or $\pm 0.3 \text{ }^{\circ}\text{C}$ (0.54 $^{\circ}\text{F}$)
N	-200 to 1300	-328 to 2372	0.1 % or $\pm 0.3 \text{ }^{\circ}\text{C}$ (0.54 $^{\circ}\text{F}$)
R	-50 to 1700	-58 to 3092	0.1 % or $\pm 0.3 \text{ }^{\circ}\text{C}$ (0.54 $^{\circ}\text{F}$) (above 300 $^{\circ}\text{C}$ [572 $^{\circ}\text{F}$])
S	-50 to 1700	-58 to 3092	0.1 % or $\pm 0.3 \text{ }^{\circ}\text{C}$ (0.54 $^{\circ}\text{F}$) (above 200 $^{\circ}\text{C}$ [392 $^{\circ}\text{F}$])
T	-200 to 300	-328 to 572	0.1 % or $\pm 0.3 \text{ }^{\circ}\text{C}$ (0.54 $^{\circ}\text{F}$)
RTD			
PT100	-200 to 600	-328 to 1112	0.1 % or $\pm 0.5 \text{ }^{\circ}\text{C}$ (0.9 $^{\circ}\text{F}$)
PT1000 (IEC 60 751)	-200 to 850	-328 to 1562	0.1 % or $\pm 0.5 \text{ }^{\circ}\text{C}$ (0.9 $^{\circ}\text{F}$)
Ni120	-80 to 260	-112 to 500	0.1 % or $\pm 0.5 \text{ }^{\circ}\text{C}$ (0.9 $^{\circ}\text{F}$)
Ni1000	-30 to 130	-22 to 266	0.1 % or $\pm 0.5 \text{ }^{\circ}\text{C}$ (0.9 $^{\circ}\text{F}$)

Advanced math (optional)

Type

24 equations provide ability to perform general arithmetic calculations including mass flow (of ideal gases), relative humidity and emissions calculations

Size

40-character equation

Functions

+, -, /, log, Ln, Exp, Xn, $\sqrt{\quad}$, Sin, Cos, Tan, mean, rolling average, standard deviation, high/median/low select, multiplexer, absolute, relative humidity

Tags

8- and 20-character tags for each block

Update rate

1 enabled Math block is updated every 125 ms

Logic equations (optional)

Number

24

Size

11 elements each

Functions

AND, OR, NAND, NOR, XOR, NOT

Tags

20-character tag for each equation

Update rate

300 ms

Energy calculations (optional) *

Functions

- Water power
- Steam power
- Steam power balance

Totalizer (optional)

Number

48 (2 per recording channel) 10-digit totals

Type

Analog, digital, F0 or timer

Statistical calculations

Average, maximum, minimum (for analog signals)

Functionality

Batch and secure totals

6-Relay module

Number of relays

6 per module

Type and maximum rating

Relay type single-pole changeover

Voltage:

- 250 V AC, 30 V DC

Current:

- 2.5 A AC, 2.5 A DC

Note. The total load for all relays within the recorder must not exceed 17.5 A.

* Includes the advanced math and totalizer options.

For further information, refer to Appendix G of the Operating Instructions (OI/RVG200-EN)

... Specification

Hybrid module

6 Analog blocks + 5 digital inputs

Analog block

Number:

- 6, galvanically isolated

Configuration options:

- Analog output, digital output or transmitter PSU

Analog output

Configurable current range:

- 0 to 20 mA

Maximum load:

- 750 Ω

Isolation:

- 500 V DC from any other I/O

Accuracy:

- 0,25 %

Digital output

Voltage:

- 24 V (nominal)

Drive:

- 22.5 mA

Isolation:

- 500 V DC from any other I/O

Transmitter PSU

22.5 mA at 24 V DC (nominal)

Isolation:

- 500 V DC from any other I/O

Digital input

Number:

- 5

Type:

- Volt-free switching inputs, or Digital 24 V switching inputs

Polarity:

- Negative (closed switch contact or 0 V = active signal)

Digital input minimum pulse:

- 125 ms

Isolation:

- 500 V DC from any other I/O *

24 V digital input switching threshold:

- Off (0): <5 V

- On (1): >15 V

Ethernet module

Physical medium

10/100BaseT

Protocols

TCP/IP, ARP, ICMP, FTP (server), HTTP,

MODBUS TCP (master/slave)

FTP server functions

- Directory selection & listing
- File upload/download
- 4, independently configurable users with full or read-only access

Web server functions

- Operator screen monitoring/selection
- Remote monitoring of recording channels, analog/digital signals, alarms, totalizers and archiving
- Full remote operation of the recorder

RS485 serial communications module

Number of ports

1 as option

Connections

RS485, 2- or 4-wire

Protocol

MODBUS RTU slave + master

Isolation

500 V DC from rest of recorder

USB connections

Number

2 (1 front and 1 rear)

Type

USB 2

Connectivity

- Mouse
- Keyboard
- Barcode scanner
(USB wedge interface – does not require a driver)
- Flash drive up to 32GB capacity

* No isolation between digital I/O on the same module

EMC

Emissions & Immunity

Meets requirements of:

- EN50081-2
- EN50082-2
- EN61326 for an industrial environment

Electrical

Power supply

- 100 to 240 V AC $\pm 10\%$ (90 min. to 264 V max.) 50/60 Hz
- 24 V DC (23.0 to 24.5 V DC)

Power consumption

25 W max.

Power interruption protection

No effect for interruptions of up to 20 ms

Safety

General safety

EN61010-1

cULus

Overvoltage Class III on mains, Class II on inputs and outputs

Pollution category 2

Isolation

500 V DC to earth (ground)

Environmental

Operating temperature range

0 to 50 °C (32 to 122 °F)

Operating humidity range

5 to 95 % RH (non-condensing)

Storage temperature range

-10 to 60 °C (14 to 140 °F)

Front panel sealing

IP66 and NEMA4X

Rear panel sealing

- IP40 (with rear cover)
- IP20 (without rear cover)

Vibration

Conforms to EN60068-2-6

Physical

Size

Height and width

144 x 144 mm (5.7 x 5.7 in.)

Depth behind panel (including terminal cover)

147 mm (5.8 in.)

Weight

2.0 kg (4.4 lb) approx. (unpacked)

Panel cutout

138 x 138 mm (5.43 x 5.43 in.)

Case/Bezel material

10 % glass-filled polycarbonate

Touch screen material

Polyester (EBA 250)

Electrical connections

Module positions

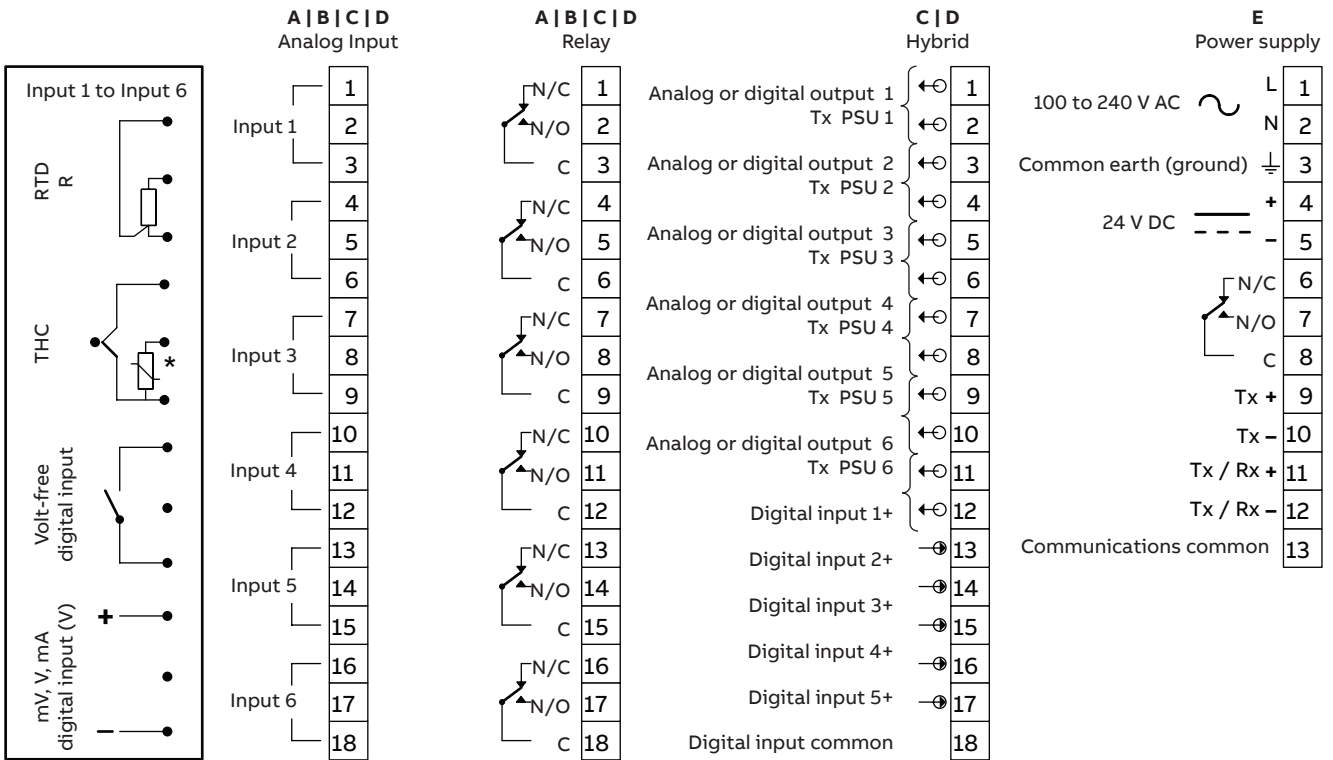
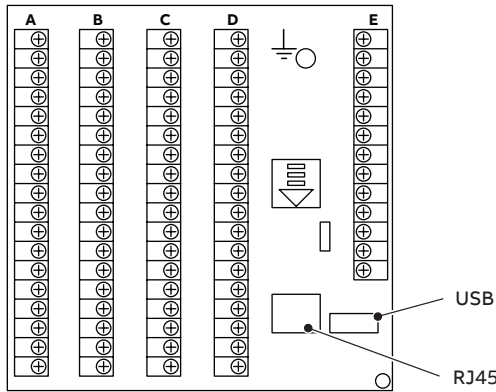

* Each thermocouple input must have either a cold junction assembly (part number CM30/0052) or shorting link (part number RVG200/0118) fitted. Each analog input card with a thermocouple input must have a minimum of 1 cold junction assembly fitted. For applications requiring maximum thermocouple accuracy, it is recommended that each thermocouple input is fitted with a cold junction assembly.

Overall dimensions

Dimensions in mm (in.)

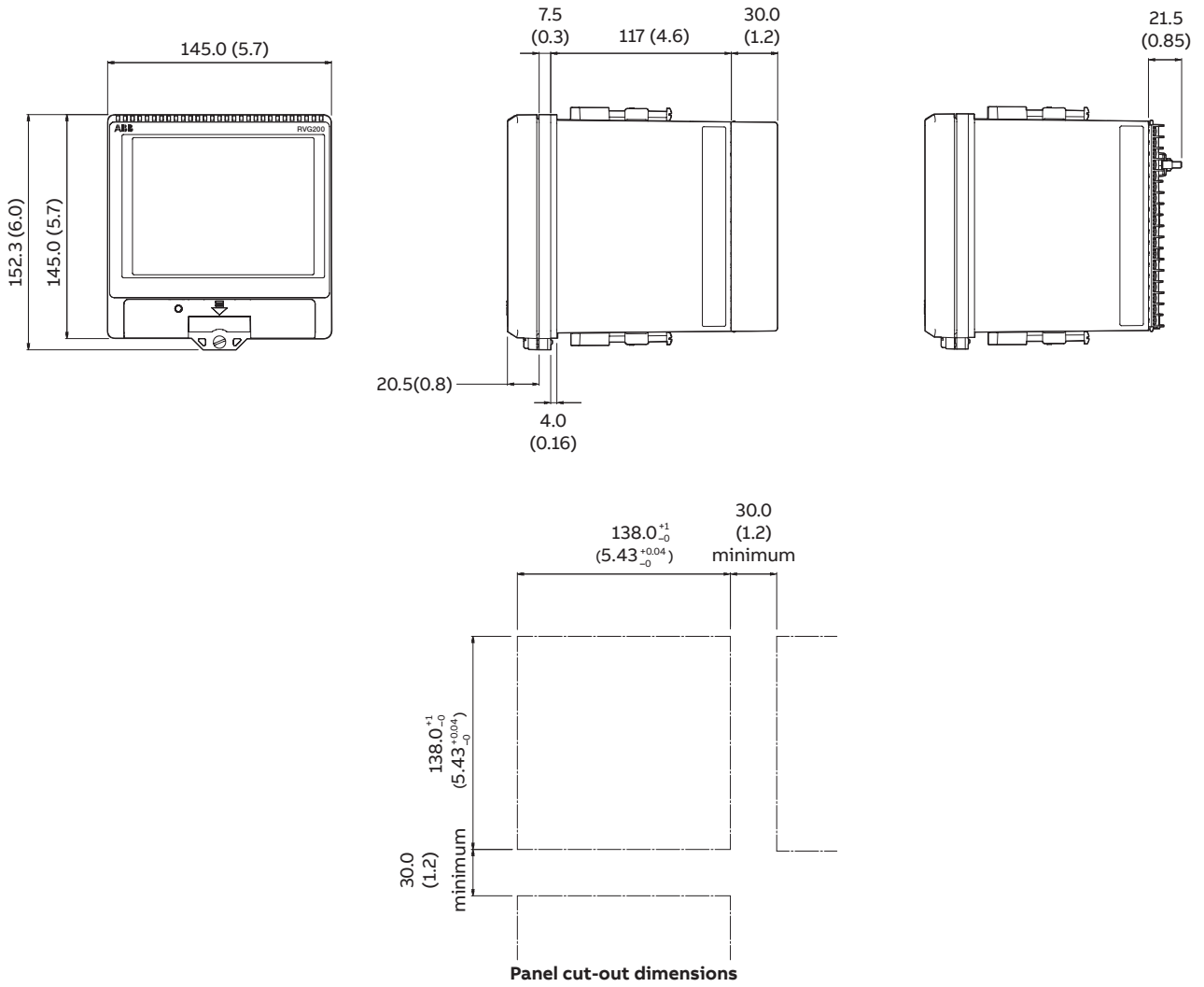

Ordering information

ScreenMaster RVG200 paperless recorder	RVG200	AN	AN	AN	AN	A	N	A	N	A	N	A	A	N	OPT
Option module A															
Not fitted		Y0													
6 analog inputs		A6													
6 relay outputs		R6													
Option module B															
Not fitted			Y0												
6 analog inputs			A6												
6 relay outputs			R6												
Option module C															
Not fitted				Y0											
6 analog inputs				A6											
Hybrid – 6 outputs (transmitter power supply, digital or analog) and 5 digital inputs				H6											
6 relay outputs				R6											
Option module D															
Not fitted					Y0										
6 analog inputs					A6										
Hybrid – 6 outputs (transmitter power supply, digital or analog) and 5 digital inputs					H6										
6 relay outputs					R6										
Internal memory size															
256 MB						A									
2 GB						D									
Expansion 1															
None							0								
Communications															
Ethernet								A							
Ethernet and RS485								B							
Approvals															
Standard										1					
cULus										2					
Configuration															
Standard (company default)													A		
Custom configuration (customer to complete and supply RVG200 custom configuration sheet (INF13/146)													B		
Engineered configuration (customer to supply configuration details required)													E		
Branding															
ABB standard														1	
Unbranded front panel and start-up screen														2	

Continued on page 21...

ScreenMaster RVG200 paperless recorder	RVG200	AN	AN	AN	AN	A	N	A	N	A	N	A	A	N	OPT
	See page 20														
Archive media															
Standard grade SD card													A		
Industrial grade 512 MB SD card													C		
Industrial grade 2 GB SD card													E		
Standard grade USB flash drive													J		
Industrial grade 512 MB USB flash drive													L		
Industrial grade 2 GB USB flash drive													N		
HMI language															
English														5	
German														1	
Spanish														3	
French														4	
Italian														2	
Chinese														6	
Portuguese														A	
Dutch														D	
Expansion 2															
None														Y	
Calibration certificate															
Certificate of calibration **															C1
Special features															
GAMP validation compatible recorder															KR
Printed instruction manual															
English															M5
German															M1
Spanish															M3
French															M4
Italian															M2
Chinese															M6
Software options															
Math & logic															N1
Totalizers/timers															N2
Batch															N3
Energy calculations (includes math & logic and totalizers/timers)															N4
User-customizable views															N5

* When a calibration certificate is ordered it is performed according to the specified configuration type:
 CUS/ENG – Inputs and outputs calibrated according to the customer supplied configuration details and ranges.
 STD – Inputs and outputs calibrated according to the instrument factory standard configuration and ranges.

Example product ordering code:
 RVG200A6H6Y0Y0A0A1A1C5Y-C1-N1-N3

Standard accessories

Included with each recorder:

- Panel-mounting clamps
- Media-door lock keys
- DataManager Pro software
- 1 CJ sensor per input card
- 5 CJ shorting links
- PC configuration software

Optional accessories

RDM500L	DataManager Pro single user license
RDM500ML	DataManager Pro multi-user license
ENG/REC	After-sales engineered configuration service
CM30/0052	Additional CJ sensor
B13328	512 MB industrial grade SD card
B13329	2 GB industrial grade SD card
B13331	512 MB industrial grade USB flash drive
B13332	2 GB industrial grade USB flash drive
RVG200/0700	6-channel analog input upgrade kit
RVG200/0701	Hybrid module upgrade kit
RVG200/0702	Relay module upgrade kit
RVG200/0703	RS485 module upgrade kit
RVG200/0706	2 GB internal memory upgrade kit
RVG200/0715	Batch upgrade
RVG200/0716	Math and logic upgrade
RVG200/0717	Totalizer upgrade
RVG200/0722	Energy calculation upgrade
RVG200/0723	User-customizable views upgrade
CD/VALRVG200	Validation package

Acknowledgments

MODBUS is a registered trademark of the Modbus-IDA organization

Sales



Service



Software



ABB Limited

Measurement & Analytics

Howard Road
St. Neots, Cambridgeshire
PE19 8EU
Tel: +44 (0)1480 475321
Fax: +44 (0)1480 217948
Email: instrumentation@gb.abb.com

ABB Inc.

Measurement & Analytics

125 E. County Line Road
Warminster, PA 18974
USA
Tel: +1 215 674 6000
Fax: +1 215 674 7183

abb.com/measurement

We reserve the right to make technical changes or modify the contents of this document without prior notice. With regard to purchase orders, the agreed particulars shall prevail. ABB does not accept any responsibility whatsoever for potential errors or possible lack of information in this document.

We reserve all rights in this document and in the subject matter and illustrations contained therein. Any reproduction, disclosure to third parties or utilization of its contents – in whole or in parts – is forbidden without prior written consent of ABB.