

# Sensyflow FMT500-IG Thermal Mass Flowmeter



## Direct mass flow measurement of gases

- No additional pressure and temperature compensation

## Digital measured value processing with improved signal quality

## Wide measuring range up to 1:150

- Factory calibration with optional DAkkS / ILAC certificate
- Process gas calibration with clean gases and gas mixtures (optional)

## High measuring accuracy

## Quick response time $\leq 0.5$ s

## Negligible pressure loss

## No moving parts, no wear, maintenance-free

## Defined and reproducible mounting position in the middle of the pipeline

- Pipe components for DN 25 ... DN 200 (1 ... 8")
- Weld-on adapters for larger diameters and rectangular ducts
- Reliable and convenient hot tap fittings

## Integral mount design with illuminated display

## Remote mount design with separate wall-mounted housing

## Communication

- PROFIBUS DPV1 or analog / HART signal

## Diagnostic and alarm functions

## Approvals for explosion protection

- ATEX
- FM / CSA
- GOST Russia

---

## Contents

<b>1</b>	<b>General information</b>	<b>3</b>
1.1	Principle of operation and construction	3
1.2	Type overview	4
1.3	Overview of Sensyflow FMT500-IG	5
<b>2</b>	<b>Specifications</b>	<b>6</b>
<b>3</b>	<b>Electrical connections</b>	<b>8</b>
<b>4</b>	<b>Ex relevant specifications</b>	<b>13</b>
4.2	Safety Specifications for the Inputs and Outputs, Model FCM2000-MC27B	15
<b>5</b>	<b>Communication</b>	<b>17</b>
5.1	HART	17
5.2	PROFIBUS DPV1	17
<b>6</b>	<b>Dimensions</b>	<b>18</b>
<b>7</b>	<b>Installation instructions</b>	<b>20</b>
7.1	Weld-on adapter for Sensyflow FMT500-IG	20
7.2	Weld-on adapter with ball valve for Sensyflow FMT500-IG	21
7.3	Integrated hot tap fitting for Sensyflow FMT500-IG	22
<b>8</b>	<b>Recommended steadying lengths according to DIN EN ISO 5167-1</b>	<b>24</b>
<b>9</b>	<b>Ordering information</b>	<b>25</b>
9.1	Additional ordering information	28
<b>10</b>	<b>Questionnaire</b>	<b>29</b>

## 1 General information

### 1.1 Principle of operation and construction

Sensyflow FMT500-IG is a thermal flowmeter for gases. The measuring principle (hot-film anemometer) allows the direct determination of mass flow and gas temperature. Taking the standard density of the gases into consideration, the standard volume flow rate can be displayed without additional pressure and temperature compensation.

The integral mount design of the Sensyflow FMT500-IG metering system comprises a transmitter, flowmeter sensor and a pipe component. In the remote design the flowmeter sensor and the transmitter are connected via a max. 50 m (164 ft.) long cable. Depending on the version, the flowmeter sensor provides the measuring signals either as PROFIBUS or as analog / HART signals. The unit is operated either remotely via PROFIBUS / HART communication or locally by using a magnetic pen.

The pipe component is available for nominal pipe sizes ranging from DN 25 ... DN 200 and in various designs. It is also possible to install the flowmeter sensor directly in square ducts or pipes with any diameter via a weld-on adapter.

For many years, thermal gas-mass flowmeters with analog design have been established as complete process measuring devices in the chemical industry. The digital Sensyflow FMT500-IG represents a logical step in the consequent development of this well-proven technology.

#### Physics of measurement

Thermal flow metering procedures use different ways to evaluate the flow dependent cooling of a heated resistor as measuring signal. In a hotfilm anemometer with temperature difference control, the heated platinum resistor is maintained at a constant overtemperature in relation to an unheated platinum sensor inside the gas flow. The heating power required for maintaining the overtemperature depends directly on the flow rate and the material properties of the gas. With a known (and constant) gas composition the mass-flow can be determined by electronically evaluating the heater current / mass-flow curve without additional pressure and temperature compensation. When using the constant power method, the temperature difference is measured which results from a constant heating power and depends on the heat quantity dissipated by the gas mass flow as well. Together with the standard density of the gas this results directly in the standard volume flow. Considering the high measuring range dynamics up to 1:150, an accuracy smaller than 1 % of the measuring value is achieved.

#### The digital Sensyflow method

With the patented digital Sensyflow method there are 4 signals available to the evaluation electronics. These include, besides the heating power, the temperatures of the fluid and the heated sensor element, which can thus be used to compensate the temperature dependency on gas characteristics. By storing the gas data in the measuring system it is possible to calculate and perform an optimum adaptation at any operating time.

#### Advantages of the digital concept

- By providing several primary and secondary signals these signals can be output in parallel via the fieldbus connection. This makes a gas temperature measurement unnecessary.
- Through the implementation of complete digital signal processing it is possible to adapt the sensor control and signal conditioning to the process. This means that it is possible to achieve optimum measuring dynamics at all times, even under changing operating conditions.
- The digital Sensyflow method is capable of providing a further enhanced measuring range.



Abb. 1: Digital measuring principle of FMT500-IG

1	CPU and signal processing
$q_m$	Gas mass flow
$T_G$	Gas temperature
A/D	Alarms, diagnostics
$U_{HS}$	Heater setpoint
$I_{HI}$	Process value of heater
$U_{HI}$	Process value of heater
$T_{HI}$	Process value of heater
$T_{GI}$	Process value of gas
$R_{MG}$	Gas temperature measuring resistor
$R_{MH}$	Heater temperature measuring resistor
$R_H$	Heating resistor
$P_H$	Heating power

- While controlling the heater power at the same time, the temperature measurement of the heating resistor sets a limit of this temperature. If errors occur in the system resulting in gas temperatures beyond the specification, the heating power is switched off and the device sends a substitute value with an additional warning signal. Both measures result in a significant prolongation of the service life for high-temperature operation and enhanced equipment safety for the user.
- The most significant application and cost advantage results from the diagnostic features of the digital Sensyflow. The functions provided allow for preventive maintenance of the measuring system and the equipment, as operating times, temperature peaks and loads in the system can be evaluated, stored, and reported. This leads to direct cost savings by preventing failures and equipment downtime.

#### Typical applications

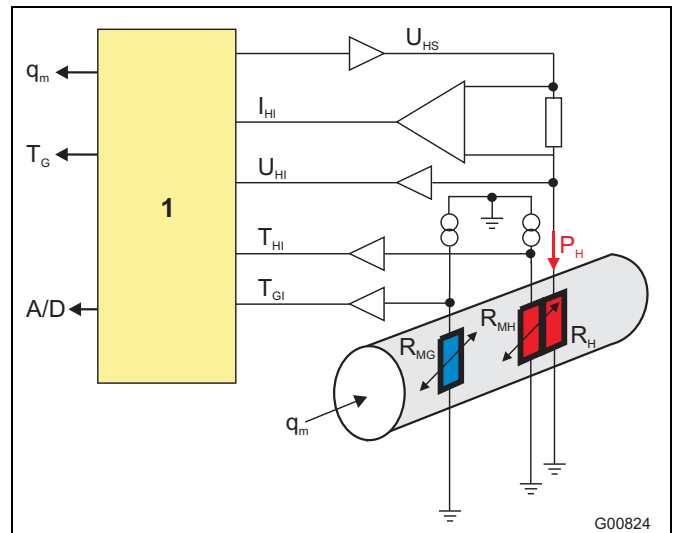
- Gas volume measurement in chemical industry and process technology
- Compressed air balancing
- Gas burner control systems
- Biogas and activation air measurement in sewage plants
- Gas measurement at air decomposers
- Hydrogen measurement in the process

## 1.2 Type overview

Type	FMT500-IG	FMT500-IG Ex version
Application	Process engineering	
Measured gases	Gases and gas mixtures with known composition	
Explosion protection	Manufacturer's declaration ATEX II 3 G and II 3 D, Zone 2/22	Certificate KEMA 03ATEX2100 ATEX II 1/2 G and II 2 D, Zone 0, 1, 21 GOST Russia Zone 0 and 1 FM/CSA Cl.1 Div. 1 or Cl.1 Div. 2
Design / Dimensions / Weight	dependent on nominal size	
Materials (standard)	Stainless steel, ceramic sensor (other materials on request)	
Process connection (standard)	Flange according to EN1092-1 Form B1, PN 40 (DIN 2635 Form C) or ASME B 16.5 Cl. 150 / 300	
System components	Transmitter Flowmeter sensor Pipe component design 1 or 2 or weld-on adapter	
Standard nominal pipe sizes	Pipe component design 1: wafer flange DN 40, 50, 65, 80, 100, 125, 150, 200 – ASME 1 1/2", 2", 3", 4", 6", 8" Pipe component design 2: partial measuring section DN 25, 40, 50, 65, 80 – ASME 1", 1 1/2", 2" Weld-on adapter for square ducts or pipe diameters ≥ DN 100 (4")	
Degree of protection	IP 67 (IP 66 for flowmeter sensor remote design)	

### Device configuration and functions

- Illuminated graphic display, 120 x 32 pixels
- Measurement of mass or standard volume flow, measured values are displayed as numbers or in bar charts
- Totalizer function with start / stop, reset and preset function
- Measurement of gas temperature
- 4 characteristic curves for different gases or pipe diameters (optional)
- Max. / Min. value storage for flow, gas temperature, and housing temperature
- Alarm and limit value functions
- Status and diagnostic signals
- Operating hours counter
- Simulation of measured values and status signals
- Users can adjust measured values locally
- Password-protected data entry menus
- Menu navigation in 4 languages
- Local operation with magnet stick
- FDT / DTM for parameterization with ASSET VISION DAT200 and DTM400 or control system
- Easy setup menu (analog / HART version) makes getting started easy
- Manufacturer's declaration regarding safety-related information according to IEC 61508 for analog / HART version (optional)

### PROFIBUS DPV1 version communication

- According to PA profile 3.0, max. transmission rate 1.5 Mbaud, direct connection to intrinsically safe PROFIBUS DP possible in hazardous areas

### Signal outputs and inputs analog / HART version

- HART communication via 4 ... 20 mA analog signal
- Current output for flow value
- 2 open-collector digital outputs, can be parameterized as:
  - Frequency output for flow and gas temperature
  - Pulse output for totalizer
  - Switching output for limit values and single or collective alarm
- 2 digital inputs, can be parameterized as:
  - External characteristic curve switchover
  - Totalizer start / stop or reset
- 24 V DC output for input/output wiring or transmitter power supply (30 mA max., not for hazardous area versions)

1.3 Overview of Sensyflow FMT500-IG



Abb. 2

- 1 Centering pin on outlet side
- 2 Flowmeter sensor FMT500-IG

- 3 Transmitter
- 4 Connection box

## 2 Specifications

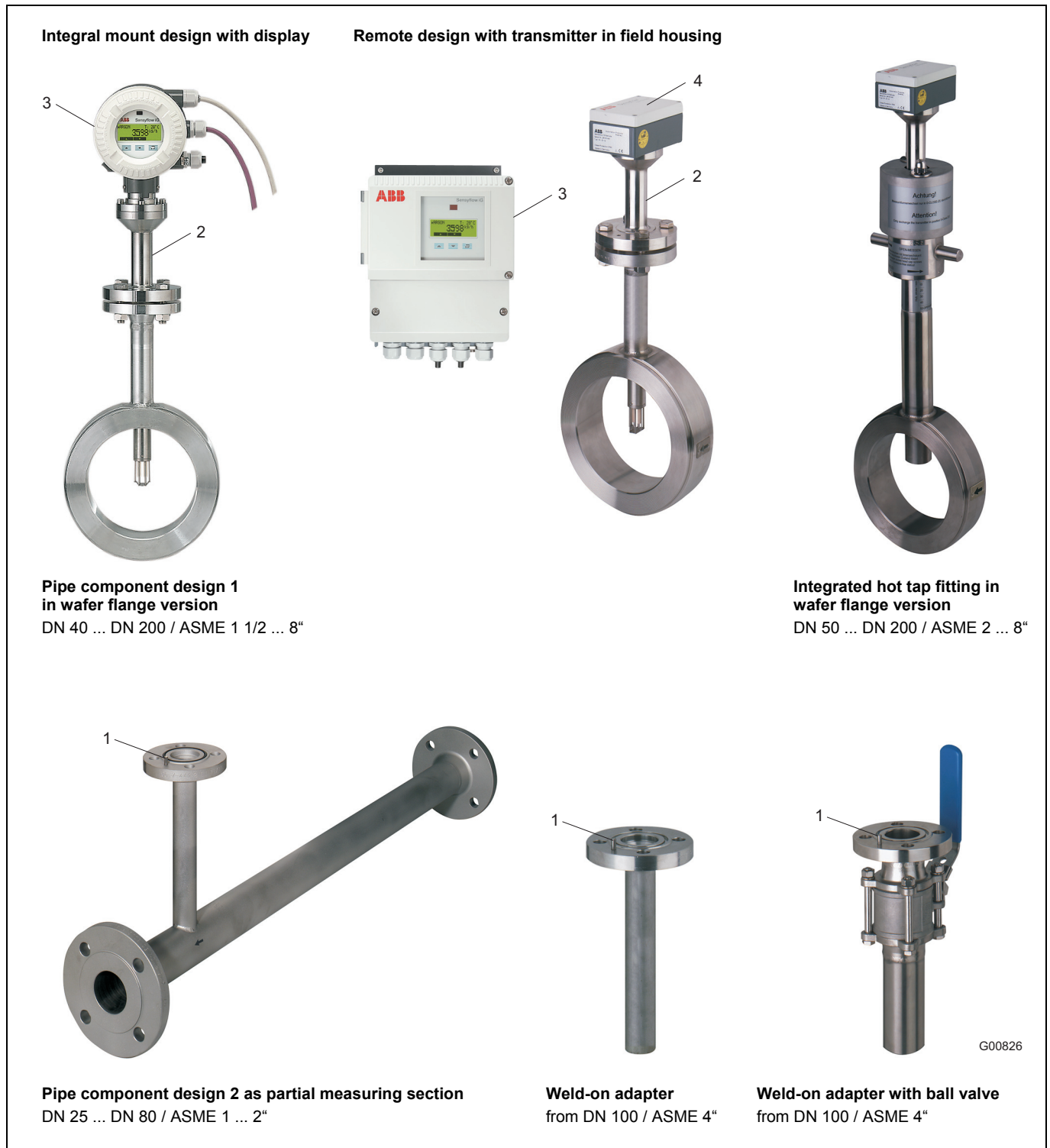
Type	FMT500-IG				FMT500-IG Hazardous area design			
Measured variable (measured gases)	Flow of gases and gas mixtures with known composition							
<b>Measuring ranges</b> Nominal diameters (DN)	<b>q<sub>min</sub></b> kg/h	<b>q<sub>max</sub></b> kg/h	<b>q<sub>min</sub></b> Nm <sup>3</sup> /h	<b>q<sub>max</sub></b> Nm <sup>3</sup> /h	<b>q<sub>min</sub></b> kg/h	<b>q<sub>max</sub></b> kg/h	<b>q<sub>min</sub></b> Nm <sup>3</sup> /h	<b>q<sub>max</sub></b> Nm <sup>3</sup> /h
	For 0 °C (32 °F) / 1013.25 hPa (14.696 psia)				For 0 °C (32 °F) / 1013.25 hPa (14.696 psia)			
DN 25	0 ...	180	0 ...	140	0 ...	160	0 ...	120
DN 40	0 ...	450	0 ...	350	0 ...	430	0 ...	330
DN 50	0 ...	750	0 ...	580	0 ...	700	0 ...	540
DN 65	0 ...	1,400	0 ...	1,100	0 ...	1,200	0 ...	920
DN 80	0 ...	2,000	0 ...	1,500	0 ...	1,700	0 ...	1,300
DN 100	0 ...	3,200	0 ...	2,500	0 ...	3,000	0 ...	2,300
DN 125	0 ...	5,600	0 ...	4,300	0 ...	5,100	0 ...	3,900
DN 150	0 ...	9,000	0 ...	7,000	0 ...	8,000	0 ...	6,200
DN 200	0 ...	15,000	0 ...	12,000	0 ...	13,000	0 ...	10,000
Up to 3000 mm	0 ...	3,000,000	0 ...	2,300,000	0 ...	2,700,000	0 ...	2,100,000
(rectangular ducts and larger diameters on request)								
<b>Measuring ranges</b> Nominal diameters (inch)	<b>q<sub>min</sub></b> lbs/h	<b>q<sub>max</sub></b> lbs/h	<b>q<sub>min</sub></b> SCFM	<b>q<sub>max</sub></b> SCFM	<b>q<sub>min</sub></b> lbs/h	<b>q<sub>max</sub></b> lbs/h	<b>q<sub>min</sub></b> SCFM	<b>q<sub>max</sub></b> SCFM
	For 15 °C (59 °F) / 1013.25 hPa (14.696 psia)				For 15 °C (59 °F) / 1013.25 hPa (14.696 psia)			
1.0	0 ...	350	0 ...	75	0 ...	310	0 ...	65
1.5	0 ...	880	0 ...	190	0 ...	860	0 ...	185
2.0	0 ...	1,500	0 ...	330	0 ...	1,400	0 ...	310
3.0	0 ...	4,000	0 ...	860	0 ...	3,300	0 ...	720
4.0	0 ...	6,400	0 ...	1,400	0 ...	6,000	0 ...	1,300
6.0	0 ...	18,500	0 ...	4,000	0 ...	16,500	0 ...	3,600
8.0	0 ...	32,000	0 ...	6,900	0 ...	27,500	0 ...	6,000
120.0	0 ...	6,600,000	0 ...	1,400,000	0 ...	6,000,000	0 ...	1,300,000
(rectangular ducts and larger diameters on request)								
Notes regarding measuring ranges	<p>The above values are reference values for applications involving air or nitrogen under atmospheric conditions (other gases available upon request).</p> <p>The values for q<sub>max</sub> can be increased by approx. 10 % upon request (with lower accuracy in the extended range).</p> <p>For hydrogen and helium, the measuring range lower limit is typically approx. 10 % of the upper limit.</p>							
<b>Measuring errors</b> Air, nitrogen	<p>Under calibration conditions in specified measuring range</p> <p>≤ ± 0.9 % of the measured value ± 0.05 % of the possible end value in this nominal diameter (see measuring ranges)</p>							
other gases	<p>≤ ± 1.8 % of the measured value ± 0.10 % of the possible end value in this nominal diameter (see measuring ranges)</p> <p>Special calibration on request</p>							
Reproducibility	< 0.2 % of the measured value, t <sub>meas</sub> = 10 s							
Effect of the temperature of the measured medium	< 0.05 % / K of the measured value (depending on the type of gas)							
Effect of the pressure of the measured medium	< 0.2 % / 100 kPa (/ bar) of the measured value (depending on the type of gas)							
Response time	T <sub>63</sub> = 0.5 s				T <sub>63</sub> = 2 s			
	T <sub>63</sub> = 2 s for zone 2/22 version with constant power method							

Type	FMT500-IG	FMT500-IG Ex version
<b>Operating conditions</b>		
Recommended inlet and outlet runs	According to DIN EN ISO 5167-1 Minimum inlet run 15 x pipe diameter D, outlet run 5 x pipe diameter D	
<b>Environmental conditions</b>		
Ambient temperature Transmitter	-25 ... 50 °C (-13 ... 122 °F) for zone 2/22 versionen: -20...50 °C (-4 ... 122 °F)	-20 ... 50 °C (-4 ... 122 °F)
Flowmeter sensor remote design	-25 ... 80 °C (-13 ... 176 °F) for zone 2/22 versionen: -20 ... 80 °C (-4 ... 176 °F)	-20 ... 80 °C (-4 ... 176 °F)
	Other ambient temperatures on request	
Storage temperature	-25 ... 85 °C (-13 ... 185 °F)	
Type of protection	IP 67 (IP 66 for flowmeter sensor remote design)	
<b>Process conditions</b>		
Operating temperature Measuring medium (flowmeter sensor)	Standard range: -25 ... 150 °C (-13 ... 302 °F) Extended range: -25 ... 300 °C (-13 ... 572 °F) Zone 2/22 version: -20 ... 150 °C (-4 ... 302 °F)	acc. to temperature classes of Ex certificates max. -20 ... 150 °C (-4 ... 302 °F) (-40 °C version on request)
Operating pressure	4 x 10 <sup>6</sup> Pa (40 bar [580 psi])	
Pressure loss (logarithmic diagram)	<p>&lt; 1.0 kPa (10 mbar [0.1450 psi]), typical value 0.1 kPa (1 mbar [0.0145 psi])</p> <p style="text-align: right;">G00796</p>	
<b>Power supply</b>		
Voltage	Universal power supply unit: 110 ... 230 V AC/DC ± 10 % (f = 48 ... 62 Hz) Low-voltage power supply unit: 24 V AC/DC ± 20 % (f = 48 ... 62 Hz)	
Power consumption	20 VA, current consumption 800 mA, slow-blow fuse of at least 2 A required	
Cable entry	M20 x 1.5 or 1/2" NPT	
<b>Output</b>		
Analog- / HART version Analog output Digital outputs Digital inputs	0/4 ... 20 mA, load < 600 Ω (IG-Ex < 400 Ω), electrical isolated, alert < 3.5 or > 22 mA 2 x passive optocoupler (approx. 100 mA) can be used as frequency, pulse or contact output 2 x 24 V lin typ. 10 mA (low < 2 mA, high > 10 mA) contact input	
<b>Installation class</b>	Overvoltage category III, degree of pollution 2	

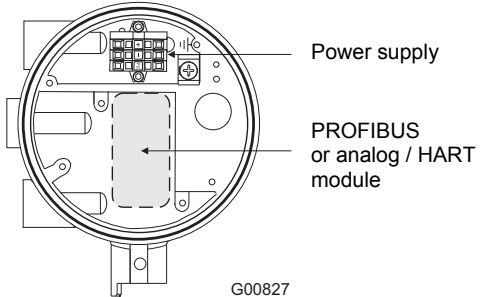
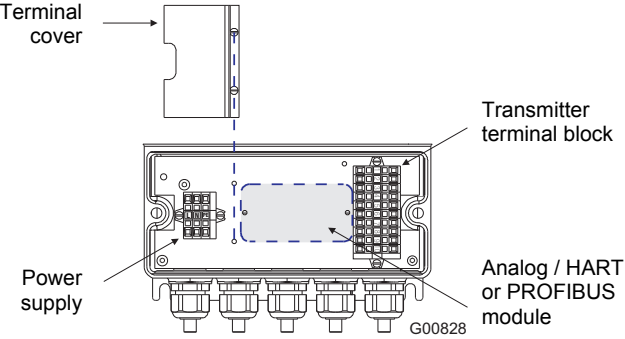
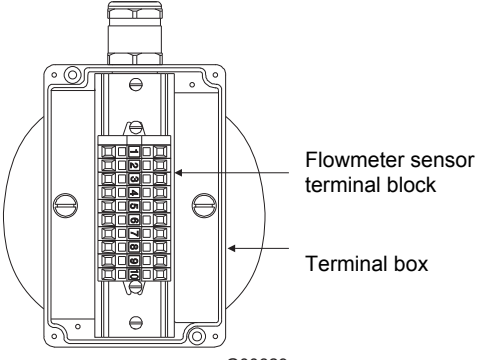

### 3 Electrical connections

<p><b>Transmitter with integral mount design</b></p> <p>L / + Phase / + terminal N / - Neutral / - terminal PE Grounding</p> <p>Wide-range power supply unit 110 ... 230 V AC / DC <math>\pm</math> 10 % or Low-voltage power supply unit 24 V AC / DC <math>\pm</math> 20 %</p>	 <p>Power supply</p> <p>PROFIBUS or analog / HART module</p> <p>G00827</p>
<p><b>Transmitter with remote mount design</b></p> <p>L / + Phase / + terminal N / - Neutral / - terminal PE Grounding</p> <p>Wide-range power supply unit 110 ... 230 V AC / DC <math>\pm</math> 10 % or Low-voltage power supply unit 24 V AC / DC <math>\pm</math> 20 %</p> <p>1:1 cable connection from transmitter terminal block to flowmeter sensor terminal block, terminals 1 ... 10 (terminal 6 not assigned).</p>	 <p>Terminal cover</p> <p>Transmitter terminal block</p> <p>Power supply</p> <p>Analog / HART or PROFIBUS module</p> <p>G00828</p>
<p><b>Flowmeter sensor with remote mount design</b></p> <p>Flowmeter sensor Terminals 1 ... 10 Cable Min. 9 wires Min. cross section Min. 0.5 mm<sup>2</sup> AWG 20 Max. cable length 50 m (164 ft.) (25 m [82 ft.] for Zone 2/22 version with constant power method)</p> <p>1:1 cable connection from transmitter terminal block to flowmeter sensor terminal block, terminals 1 ... 10 (terminal 6 not assigned).</p> <p>Place one side of the cable shield in the metal cable gland for the terminal box.</p>	 <p>Flowmeter sensor terminal block</p> <p>Terminal box</p> <p>G00829</p>

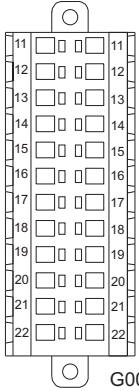
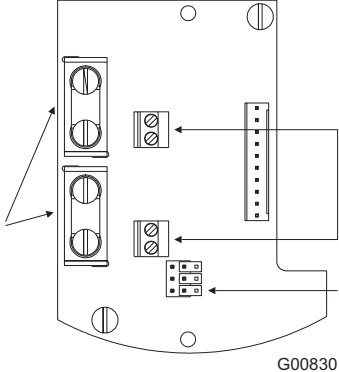

<p><b>Analog / HART module</b></p> <p>11 Shield          12 + I<sub>out</sub> analog output / HART          13 - I<sub>out</sub> analog output / HART          14 + 24 V DC for external supply, 30 mA max.          15 GND 24 V          16 D<sub>out</sub> 1          17 D<sub>out</sub> 2          18 GND D<sub>out</sub> (D<sub>out</sub> 1 + 2)          19 D<sub>in</sub> 1          20 D<sub>in</sub> 2          21 GND D<sub>in</sub> (D<sub>in</sub> 1 + 2)          22 Shield</p>	 <p style="text-align: center;">G00831</p>
<p><b>PROFIBUS module</b></p> <p>A PROFIBUS DPV1 in / out signal          B PROFIBUS DPV1 in / out signal</p> <p><b>Note:</b>          The system design is such that the entire bus connection will be interrupted if you disconnect the PROFIBUS cable on the device. As an alternative, please consider the version with DP M12 connection socket (Section 3.1.3 ).</p> <p>1) Note regarding terminating resistor: The bus termination with jumpers should only be used if just the device is connected to this PROFIBUS line.</p> <p>The incoming and outgoing PROFIBUS cables are connected to terminals A (green cable) and B (red cable) respectively. The other terminal blocks must not be used (CAN bus, for internal use only).</p>	 <p style="text-align: center;">G00830</p>

### 3.1.1 Designation

Transmitter with remote mount design	Flowmeter sensor with remote mount design	Integral mount design
 II 3G EEx nA II T4 II 3D IP 67 T 115 °C $T_{amb} = -20 \dots 50 \text{ °C} (-4 \dots 122 \text{ °F})$	 II 3G EEx nA II T4 II 3D IP 66 T 150 °C $T_{amb} = -20 \dots 80 \text{ °C} (-4 \dots 176 \text{ °F})$ $T_{medium} = -20 \dots 150 \text{ °C} (-4 \dots 302 \text{ °F})$	 II 3G EEx nA II T4 II 3D IP 67 T 150 °C $T_{amb} = -20 \dots 50 \text{ °C} (-4 \dots 122 \text{ °F})$ $T_{medium} = -20 \dots 150 \text{ °C} (-4 \dots 302 \text{ °F})$

### 3.1.2 Examples for connecting peripherals (Analog / HART version)



Abb. 3

### 3.1.3 PROFIBUS DPV1 communication with DP M12 connector socket

The version with PROFIBUS DP M12 connector socket allows disconnection of the device from the bus without interrupting PROFIBUS DP operation. Instead of the center cable gland an assembled and wired DP M12 connector socket is supplied.

For connection to the PROFIBUS DP line you need 1 T-plug, cable socket and cable plug (see accessories).

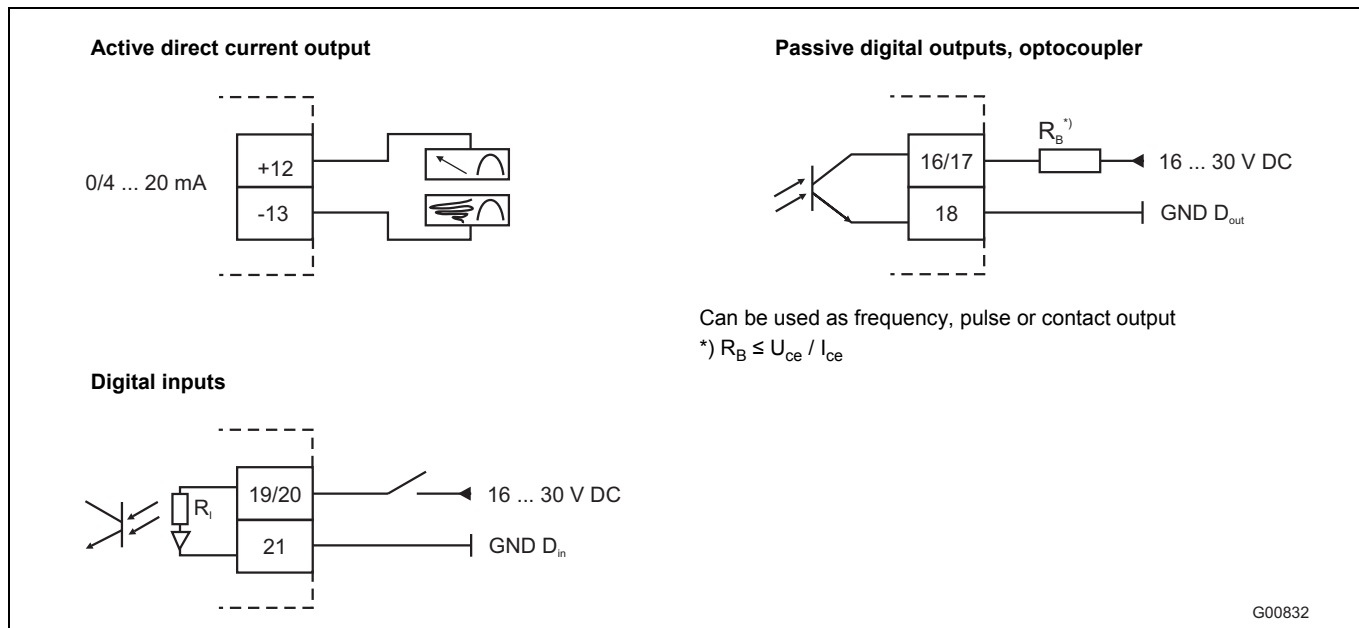
Type of protection of the plug-in connections: IP 66.

Only available for non-Ex devices in integral mount design.

Please refer to Data Sheet 10/63-6.40 for other versions of T-plugs and appropriate DP connector plugs.

#### Pin assignment of the device

Pin	Signal	Description
1	VP	+ 5 V
2	RxD/TxD-N	Receive / transmit data line A (green wire)
3	DGND	Data transmission potential
4	RxD/TxD-P	Receive / transmit data line B (red wire)
5	Shield	Shield / protective earth
Thread	Shield	Shield / protective earth

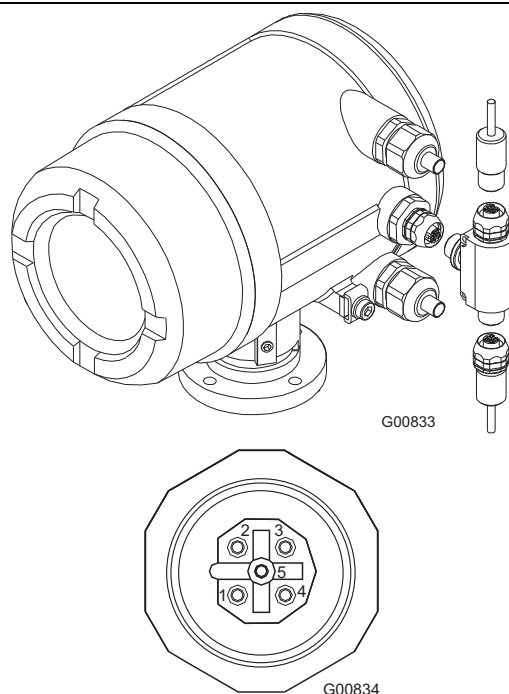

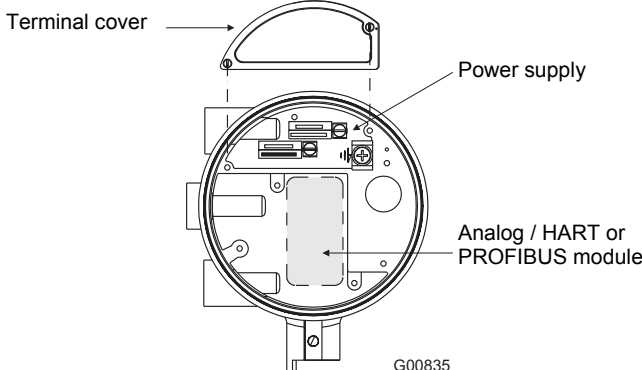
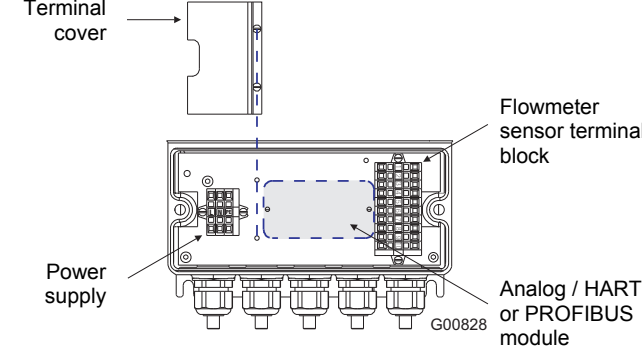
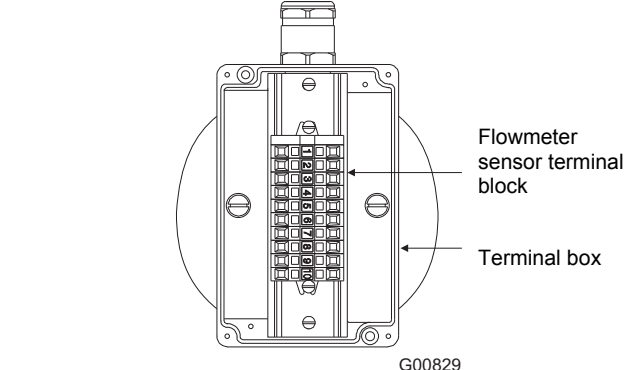
<p><b>Transmitter with integral mount design</b></p> <p>L / + Phase / + terminal N / - Neutral / - terminal PA Potential equalization</p> <p>Wide-range power supply unit 110 ... 230 V AC / DC <math>\pm</math> 10 %, 20 VA 48 ... 62 Hz, <math>U_{max}</math> = 250 V or</p> <p>Low-voltage power supply unit 24 V AC / DC <math>\pm</math> 20 %, 20 VA 48 ... 62 Hz, <math>U_{max}</math> = 29 V</p> <p>Type of protection for power supply connection: Ex e (ATEX, GOST), XP (FM, CSA)</p> <p>Before opening the cover to the connection area, remove the safety locking device and reattach it after closing the housing.</p>	 <p>Terminal cover</p> <p>Power supply</p> <p>Analog / HART or PROFIBUS module</p> <p>G00835</p>
<p><b>Transmitter with remote mount design</b></p> <p>L / + Phase / + terminal N / - Neutral / - terminal PE Grounding</p> <p>Wide-range power supply unit 110 ... 230 V AC / DC <math>\pm</math> 10 %, 20 VA 48 ... 62 Hz, <math>U_{max}</math> = 250 V or</p> <p>Low-voltage power supply unit 24 V AC / DC <math>\pm</math> 20 %, 20 VA 48 ... 62 Hz, <math>U_{max}</math> = 29 V</p> <p>1:1 cable connection from transmitter terminal block to flowmeter sensor terminal block, terminals 1 ... 10 (terminal 6 not assigned)</p> <p>Type of protection for flowmeter sensor connection: Ex ia (ATEX, GOST), IS (FM, CSA)</p>	 <p>Terminal cover</p> <p>Power supply</p> <p>Flowmeter sensor terminal block</p> <p>Analog / HART or PROFIBUS module</p> <p>G00828</p>
<p><b>Flowmeter sensor with remote mount design</b></p> <p>Type of protection Ex ia (ATEX, GOST), IS (FM, CSA)</p> <p>Flowmeter sensor Terminals 1 ... 10</p> <p>Cable Min. 9 wires</p> <p>Min. cross section Min. 0.5 mm<sup>2</sup> AWG 20</p> <p>Max. cable length 25 m (82 ft.)</p> <p>1:1 cable connection from transmitter terminal block to flowmeter sensor terminal block, terminals 1 ... 10 (terminal 6 not assigned)</p>	 <p>Flowmeter sensor terminal block</p> <p>Terminal box</p> <p>G00829</p>

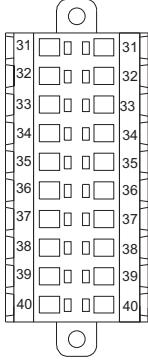
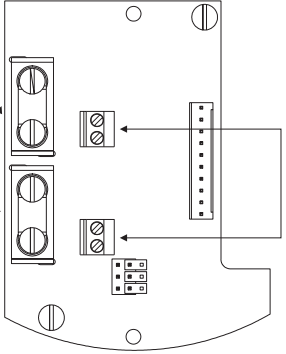
<p><b>Analog / HART module</b></p> <p>31 + I<sub>out</sub> analog output / HART          32 - I<sub>out</sub> analog output / HART          33 D<sub>out</sub> 1          34 GND D<sub>out</sub> (D<sub>out</sub> 1)          35 D<sub>out</sub> 2          36 GND D<sub>out</sub> (D<sub>out</sub> 2)          37 D<sub>in</sub> 1          38 GND D<sub>in</sub> (D<sub>in</sub> 1)          39 D<sub>in</sub> 2          40 GND D<sub>in</sub> (D<sub>in</sub> 2)</p> <p>Type of protection: Ex ib or Ex e (ATEX, GOST), IS or XP, NI (FM, CSA)</p> <p>When connecting the fieldbus / signal lines, the safety-related parameters in the relevant certificates must be observed.</p>	 <p style="text-align: right;">G00836</p>
<p><b>PROFIBUS module</b></p> <p>A PROFIBUS DPV1 in / out signal          B PROFIBUS DPV1 in / out signal</p> <p>Type of protection Ex ib (ATEX, GOST), IS (FM, CSA)</p> <p>Connect to intrinsically safe PROFIBUS DP only (integral and remote mount designs)</p> <p>Bus termination internally via 150 Ω resistor or externally according to RS485 IS specification</p> <p>When connecting the fieldbus/signal lines, the safety-related parameters in the relevant certificates must be observed.</p>	 <p style="text-align: right;">G00837</p>

## 4 Ex relevant specifications



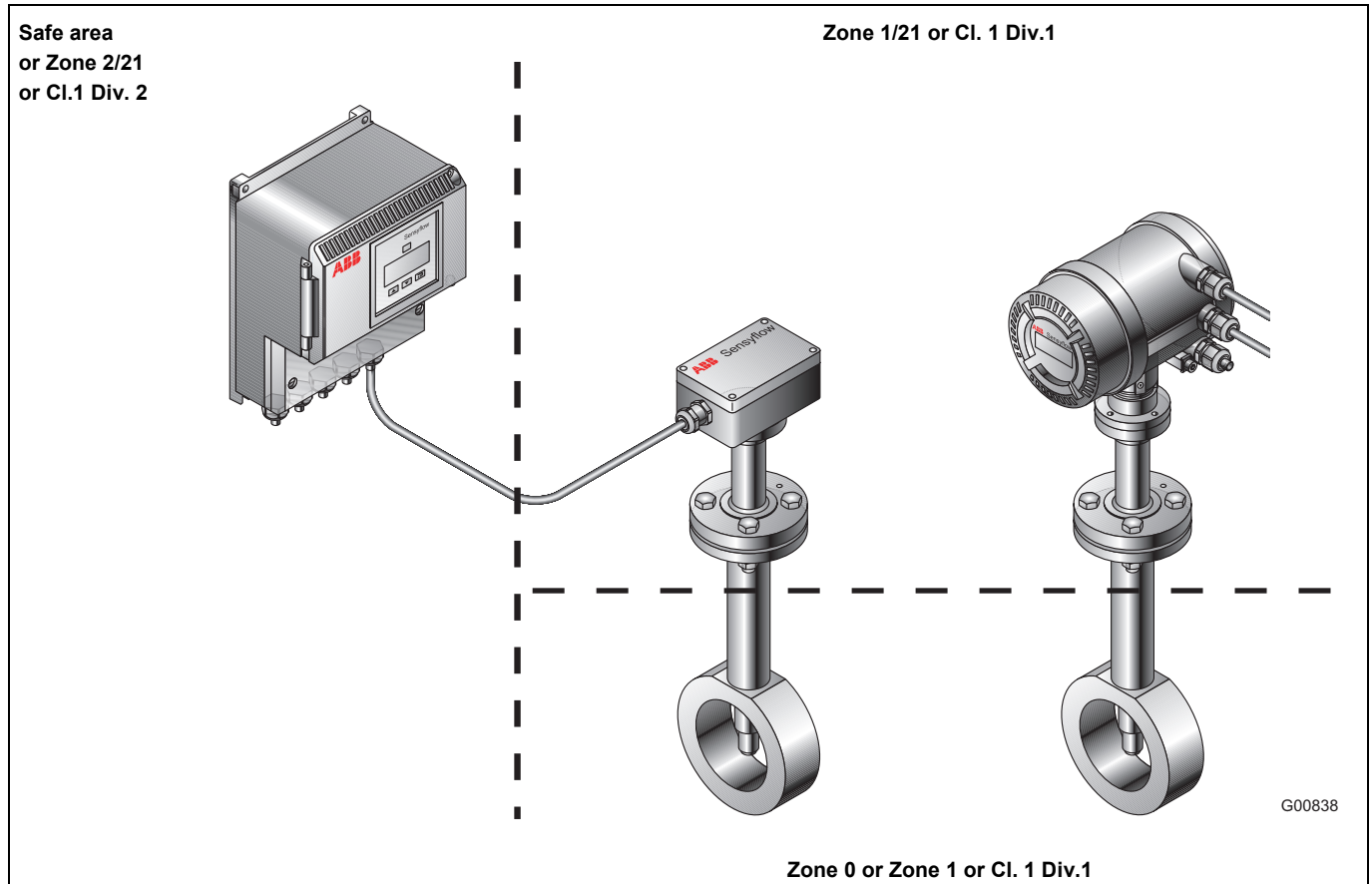

### 4.1.1 Options regarding installation in potentially explosive atmospheres



### 4.1.2 ATEX designations

Transmitter, remote mount design	Flowmeter sensor, remote mount design	Integral mount design
Zone 2/21 Ex II 3(1) G EEx nA [ia] [ib] IIC T4 II 2 D T 115 °C T <sub>amb</sub> = -20 ... 50 °C (-4 ... 122 °F)	Terminal box Zone 1, flowmeter sensor Zone 0 Ex II 1/2 G EEx ia IIC T4 II 2 D T 80 °C  Terminal box and flowmeter sensor Zone 1 Ex II 2 G EEx ia IIC T4...T1 II 2 D T 100 °C or 200 °C or 300 °C T <sub>amb</sub> = -20 ... 80 °C (-4 ... 176 °F)	Transmitter Zone 1, flowmeter sensor Zone 0 Ex II 1/2 G EEx de [ia] [ib] IIC T4 II 2 D T 115 °C  Transmitter and flowmeter sensor Zone 1 Ex II 2 G EEx de [ia] [ib] IIC T4...T1 II 2 D T 115 °C or 200 °C or 300 °C T <sub>amb</sub> = -20 ... 50 °C (-4 ... 122 °F)
Optional -40 °C for ambient temperature	Optional -40 °C for ambient temperature	Optional -40 °C for ambient temperature

### 4.1.3 GOST R designations (Russia)



Transmitter, remote mount design	Flowmeter sensor, remote mount design	Integral mount design
 <b>2Ex nA [ia] [ib] IIC T4 or 2Ex nA [ia] IIC T4 DIP A21 T<sub>A</sub>115 °C, IP 67</b>  T <sub>amb</sub> = -20 ... 50 °C (-4 ... 122 °F)	 Terminal box Zone 1, flowmeter sensor Zone 0  <b>Ex ia IIC T4 DIP A21 T<sub>A</sub>80 °C, IP 66</b>  Terminal box and flowmeter sensor Zone 1   <b>Ex ia IIC T4...T1 DIP A21 T<sub>A</sub>100 / 200 / 300 °C, IP 66</b>  T <sub>amb</sub> = -20 ... 80 °C (-4 ... 176 °F)	 Transmitter Zone 1, flowmeter sensor Zone 0  <b>2Ex de [ia] [ib] IIC T4 or 2Ex de [ia] IIC T4 DIP A21 T<sub>A</sub>115 °C, IP 67</b>  Transmitter and flowmeter sensor Zone 1   <b>2Ex de [ia] [ib] IIC T4...T1 or 2Ex de [ia] IIC T4...T1 DIP A21 T<sub>A</sub>100 / 200 / 300 °C, IP 67</b>  T <sub>amb</sub> = -20 ... 50 °C (-4 ... 122 °F)

### 4.1.4 Temperature table for ATEX and GOST R versions (Russia)



Sensyflow FMT500-IG, integral mount design				
Temperature class	Surface temperature	Process temperature	Flowmeter sensor	Transmitter
T4	T 115 °C	-20 ... 80 °C (-4 ... 176 °F)	Cat. 1G / Zone 0	Cat. 2G/2D / Zone 1/21
T4	T 115 °C	-20 ... 100 °C (-4 ... 212 °F)	Cat. 2G / Zone 1	Cat. 2G/2D / Zone 1/21
T3	T 115 °C	-20 ... 100 °C (-4 ... 212 °F)	Cat. 2G / Zone 1	Cat. 2G/2D / Zone 1/21
T2	T 200 °C <sup>1)</sup>	-20 ... 200 °C (-4 ... 392 °F) <sup>1)</sup>	Cat. 2G / Zone 1	Cat. 2G/2D / Zone 1/21
T1	T 300 °C <sup>1)</sup>	-20 ... 300 °C (-4 ... 572 °F) <sup>1)</sup>	Cat. 2G / Zone 1	Cat. 2G/2D / Zone 1/21
Sensyflow FMT500-IG transmitter, remote mount design				
Temperature class	Surface temperature			Transmitter
T4	T 115 °C			Cat. 3G/2D / Zone 2/21
Sensyflow FMT500-IG flowmeter sensor, remote mount design				
Temperature class	Surface temperature	Process temperature	Flowmeter sensor	Terminal box
T4	T 80 °C	-20 ... 80 °C (-4 ... 176 °F)	Cat. 1G / Zone 0	Cat. 2G/2D / Zone 1/21
T4	T 100 °C	-20 ... 100 °C (-4 ... 212 °F)	Cat. 2G / Zone 1	Cat. 2G/2D / Zone 1/21
T3	T 100 °C	-20 ... 100 °C (-4 ... 212 °F)	Cat. 2G / Zone 1	Cat. 2G/2D / Zone 1/21
T2	T 200 °C <sup>1)</sup>	-20 ... 200 °C (-4 ... 392 °F) <sup>1)</sup>	Cat. 2G / Zone 1	Cat. 2G/2D / Zone 1/21
T1	T 300 °C <sup>1)</sup>	-20 ... 300 °C (-4 ... 572 °F) <sup>1)</sup>	Cat. 2G / Zone 1	Cat. 2G/2D / Zone 1/21

<sup>1)</sup> Temperatures correspond to ATEX and GOST R temperature classes, max. process temperature for flowmeter sensor -20 ... 150 °C (-4 ... 302 °F)

### 4.1.5 FM designations with temperature information

Transmitter, remote mount design	Flowmeter sensor, remote mount design	Integral mount design
 <b>NI CLASS I DIV2 Group: A,B,C,D, CLASS I Zone 2 AEx nA IIC T4...T1</b>  <b>DIP CLASS II, III DIV1 and 2 Group: E,F,G</b>  <b>IS Circuits for CLASS I DIV1 Group: A,B,C,D, CLASS I Zone 0 AEx ia IIC</b>  T <sub>amb</sub> = -20 ... 50 °C (-4 ... 122 °F)	 <b>IS CLASS I DIV1 Group: A,B,C,D, CLASS I Zone 0 AEx ia IIC T4...T1</b>  <b>DIP CLASS II, III DIV1 and 2 Group: E,F,G</b>  <b>NI CLASS I, II, III DIV2, Group: A,B,C,D, CLASS I Zone 2 Group: IIC T4...T1</b>  T <sub>amb</sub> = -20 ... 80 °C (-4 ... 176 °F) T <sub>medium</sub> = -20 ... 150 °C (-4 ... 302 °F) T <sub>4/T3,medium</sub> = -20 ... 100 °C (-4 ... 212 °F) T <sub>2,medium</sub> = -20 ... 200 °C (-4 ... 392 °F) T <sub>1,medium</sub> = -20 ... 300 °C (-4 ... 572 °F)	 <b>XP CLASS I DIV1 Group: B,C,D, CLASS I, Zone 1 II B T4...T1</b>  <b>IS Circuits for CLASS I DIV1 Group: B,C,D, CLASS I Zone 0 AEx ia IIC</b>  <b>DIP CLASS II,III DIV1 and 2 Group: E,F,G</b>  <b>NI CLASS I, II, III DIV2, Group: A,B,C,D,F,G, CLASS I Zone 2 Group: IIC T4...T1</b>  T <sub>amb</sub> = -20 ... 50 °C (-4 ... 122 °F) T <sub>medium</sub> = -20 ... 150 °C (-4 ... 302 °F) T <sub>4/T3,medium</sub> = -20 ... 100 °C (-4 ... 212 °F) T <sub>2,medium</sub> = -20 ... 200 °C (-4 ... 392 °F) T <sub>1,medium</sub> = -20 ... 300 °C (-4 ... 572 °F)

#### 4.1.6 CSA designations with temperature information

Transmitter, remote mount design	Flowmeter sensor, remote mount design	Integral mount design
 <p>CLASS I DIV2, Group: A,B,C,D, CLASS I Zone 2 Ex nA II T4...T1</p> <p>CLASS II, III DIV1 and 2 Group: E,F,G</p> <p>Associated Equipment [Ex ia] CLASS I DIV1 Group: A,B,C,D [Ex ia] IIC</p> <p><math>T_{amb} = -20 \dots 50 \text{ }^{\circ}\text{C} (-4 \dots 122 \text{ }^{\circ}\text{F})</math></p>	 <p>Intrinsically safe Exia CLASS I DIV1 Group: A,B,C,D, Ex ia IIC T4...T1</p> <p>CLASS II, III DIV1 and 2 Group: E,F,G</p> <p>CLASS I DIV2, Group: A,B,C,D, Ex nA II T4...T1</p> <p><math>T_{amb} = -20 \dots 80 \text{ }^{\circ}\text{C} (-4 \dots 176 \text{ }^{\circ}\text{F})</math>  <math>T_{medium} = -20 \dots 150 \text{ }^{\circ}\text{C} (-4 \dots 302 \text{ }^{\circ}\text{F})</math>  <math>T4/T3_{medium} = -20 \dots 100 \text{ }^{\circ}\text{C} (-4 \dots 212 \text{ }^{\circ}\text{F})</math>  <math>T2_{medium} = -20 \dots 200 \text{ }^{\circ}\text{C} (-4 \dots 392 \text{ }^{\circ}\text{F})</math>  <math>T1_{medium} = -20 \dots 300 \text{ }^{\circ}\text{C} (-4 \dots 572 \text{ }^{\circ}\text{F})</math></p>	 <p>CLASS I DIV1 Group: B,C,D,F,G, CLASS I, Zone 1 II B T4...T1</p> <p>CLASS I Zone 1/0 Ex d [ia] [ib] IIC T4...T1 or Ex d [ia] IIC T4...T1</p> <p>CLASS II, III DIV1 and 2 Group: E,F,G</p> <p>CLASS I, II, III DIV2, Group: A,B,C,D,F,G, CLASS I Zone 2 Ex nA II T4...T1</p> <p><math>T_{amb} = -20 \dots 50 \text{ }^{\circ}\text{C} (-4 \dots 122 \text{ }^{\circ}\text{F})</math>  <math>T_{medium} = -20 \dots 150 \text{ }^{\circ}\text{C} (-4 \dots 302 \text{ }^{\circ}\text{F})</math>  <math>T4/T3_{medium} = -20 \dots 100 \text{ }^{\circ}\text{C} (-4 \dots 212 \text{ }^{\circ}\text{F})</math>  <math>T2_{medium} = -20 \dots 200 \text{ }^{\circ}\text{C} (-4 \dots 392 \text{ }^{\circ}\text{F})</math>  <math>T1_{medium} = -20 \dots 300 \text{ }^{\circ}\text{C} (-4 \dots 572 \text{ }^{\circ}\text{F})</math></p>

## 4.2 Safety Specifications for the Inputs and Outputs, Model FCM2000-MC27B

### 4.2.1 PROFIBUS DPV1 communication

Output circuit	ATEX and GOST versions: Intrinsically safe EEx ib IIC / IIB			
	FM/CSA versions: IS acc. to control drawings V14224-6 ... 1222 ..., V14224-6 ... 2222 ..., V14224-7 ... 1122 ..., V14224-7 ... 2122 ...			
PROFIBUS DP	$U_o = \pm 3.72 \text{ V}$			
RS 485_IS interface	$I_o$	$P_o$	EEx ib IIC/IIB	
Terminals X2, X3	[mA]	[mW]	$C'$ [nF/km]	$L'/R'$ [mH/ $\Omega$ ]
Terminal A/B	$\pm 155$	$\pm 144.2$	$\leq 250$	$\leq 28.5$
	Min. cable cross section 0.2 mm Max. input voltage $U_i$ : $\pm 4.20 \text{ V}$ $C_i$ : 0 nF Max. input current $I_i$ : $\pm 2.66 \text{ A}$ $L_i$ : 0 mH Electrical isolation of RS 485_IS PROFIBUS fieldbus signals A and B Cable shield is connected to potential equalization Use approved RS 485_IS interface / barriers only to disconnect intrinsically safe and non-intrinsically safe PROFIBUS connections			

## 4.2.2 Analog / HART communication

Output circuit	ATEX and GOST versions: Intrinsically safe EEx ib IIC / IIB			ATEX and GOST versions: Non-intrinsically safe $U_{max} = 60 \text{ V}$	
	FM / CSA versions: IS acc. to control drawings V14224-6 ... 1212 ... IS, V14224-6 ... 2212 ... IS, V14224-7 ... 1112 ... IS, V14224-7 ... 2112 ... IS			FM / CSA versions: XP, NI, DIP acc. to control drawings V14224-6 ... 1212 ..., V14224-6 ... 2212 ..., V14224-7 ... 1112 ..., V14224-7 ... 2112 ... $U_{max} = 90 \text{ V}$	
Current output	$U_o = 17.2 \text{ V}$	$U_i = 30 \text{ V}$	$I_i = 100 \text{ mA}$		$U_B = 30 \text{ V}$
Active	$I_o$	$P_o$	EEx ib IIC		$I_B = 30 \text{ mA}$
Terminal 31 + 32	[mA]	[mW]	$C_i$ [nF]	$L_i$ [mH]	
	78.3	337	2.0	0.25	
	Characteristic curve: Linear $C_o = 353 \text{ nF}$ , $L_o = 4 \text{ mH}$ Connect to passive, intrinsically safe circuits only. Terminal 32 is connected to potential equalization (PA). Use only approved separators / barriers.				
Digital output Passive $D_{out1}$ : Terminal 33 + 34 $D_{out2}$ : Terminal 35 + 36	$U_i = 15 \text{ V}$ $I_i = 30 \text{ mA}$ $P_i = 115 \text{ mW}$		$C_i = 2.0 \text{ nF}$ $L_i = 0.250 \text{ mH}$		$U_B = 30 \text{ V}$ $I_B = 100 \text{ mA}$
Digital input Passive $D_{in1}$ : Terminal 37 + 38 $D_{in2}$ : Terminal 39 + 40	$U_i = 30 \text{ V}$ $I_i = 250 \text{ mA}$ $P_i = 1.1 \text{ W}$		$C_i = 2.0 \text{ nF}$ $L_i = 0.250 \text{ mH}$		$U_B = 30 \text{ V}$ $I_B = 100 \text{ mA}$

### Special requirements:

The output current circuits are designed such that they can be connected to either intrinsically safe or non-intrinsically safe current circuits. However, intrinsically safe and non-intrinsically safe circuits must not be mixed or combined.

The rated voltage of non-intrinsically safe current circuits is:

- for ATEX and GOST versions  $U_m = 60 \text{ V}$
- for FM and CSA versions  $U_m = 90 \text{ V}$  (XP, NI, DIP).
- Make sure that the cover of the power terminal box is always closed properly. When using the device with intrinsically safe output current circuits it is permissible to open the terminal box.
- It is recommended to use the enclosed cable glands for the output current circuits, according to the type of explosion protection:  
intrinsically safe = blue; non-intrinsically safe = black.

- The flowmeter sensor and the transmitter housing must be connected to an equipotential bonding system. When using intrinsically safe current outputs proper equipotential bonding must be ensured along the current circuits.
- Make sure that the measuring pipe materials are resistant to possible corrosive substances in the measuring medium. This is the user's responsibility.

### Notice:

The values indicated here are taken from the respective approval certificates. Always observe the specifications and supplements in the approvals (ATEX, FM, CSA, GOST Russia).



## 5 Communication

### 5.1 HART

HART protocol Rev. 6.0 is used for digital communication between a process control system or PC, a hand-held terminal and the field device. It can be used to send all device and measuring point parameters from the transmitter to the process control system or PC. Conversely, it also provides a means of reconfiguring the transmitter.

Digital communication utilizes an alternating current superimposed on the analog output (4 ... 20 mA) that does not affect any meters connected to the output.

The ASSET VISION DAT200 and DTM400 program can be used for operation and configuration purposes. This is a piece of universal communication software for intelligent field devices based on FDT/DTM technology. Data can be exchanged with a comprehensive range of field devices using various means of communication. The main applications include parameter display, configuration, diagnostics, recording, and data management for all intelligent field devices that specifically meet the communication requirements involved.

Basic functions (such as the measuring range end value or certain mass flow units) can be parameterized with the universal HART DTM. If you use the FMT500-IG HART DTM, you will have access to the full range of functions.

#### Transmission method

FSK modulation at current output of 4 ... 20 mA based on the Bell 202 standard. Max. signal amplitude 1.2 mA<sub>SS</sub>.

#### Load

Min. 250 Ω, max. 600 Ω (IG-Ex < 400 Ω)

Max. cable length 1,500 m AWG 24, twisted and shielded (for standard and Zone 2/22 devices).

Max. cable length for Ex devices depends on the safety specifications in the certificates.

#### Baud rate

1,200 baud

Log. 1 representation: 1200 Hz

Log. 0 representation: 2200 Hz

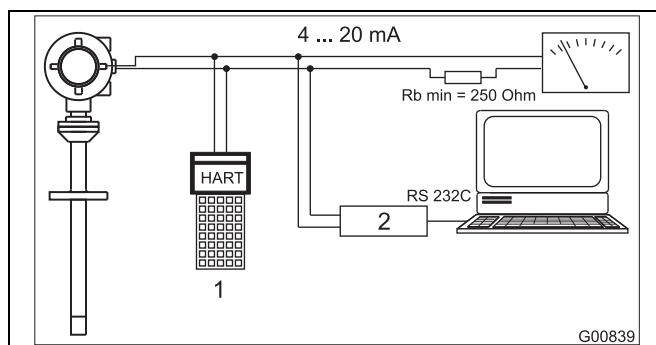

Fig. 4

- 1 Handheld terminal
- 2 FSK modem

### 5.2 PROFIBUS DPV1

With the Sensyflow FMT500-IG thermal mass flowmeter plus PROFIBUS interface, bus communication is based on the "Profile For Process Control Devices" Version 3.0 (PA Profile 3.0) of October 1999. PROFIBUS DP (RS 485 transmission) is used for the bus interface and the acyclic PROFIBUS DPV1 services are supported.

#### PROFIBUS interface parameters

- DPV1 communication without alarms
- Master C1 and C2 support
- Max. transmission rate: 1.5 Mbaud
- ID number: 0x05CA
- GSD file name: ABB\_05CA.GSD

The cables for the PROFIBUS connection must meet the following parameters in accordance with PROFIBUS specification EN 50170 part 8-2:

Parameter	DP, cable type A, shielded
Surge impedance in Ω	135 ... 165 at a frequency of 3 ... 20 MHz
Effective capacitance (pF/m)	30
Loop resistance (Ω/km)	≤ 110
Solid conductor	AWG 22/1
Flexible conductor	> 0.32 mm <sup>2</sup>

As with the analog / HART version, you can parameterize the device using ASSET VISION DAT200 and DTM400 and FMT500-IG PROFIBUS-DTM.

Direct connection to intrinsically safe PROFIBUS DP lines is permitted, provided you use approved models and comply with safety-related parameters in accordance with certificates (see figure). The line length and number of bus nodes depend on the Ex barrier used.

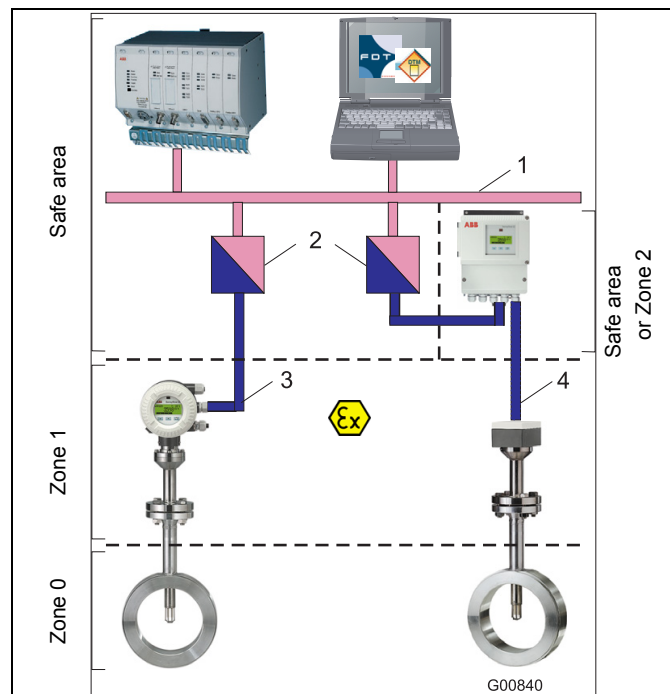

Fig. 5

- 1 PROFIBUS DPV1 non-intrinsically safe
- 2 Ex barrier PROFIBUS DP (RS 485\_IS interface)
- 3 PROFIBUS DP intrinsically safe
- 4 Intrinsically safe circuit

## 6 Dimensions

Flowmeter sensor (integral mount design)	Transmitter (remote mount design)	Flowmeter sensor (remote mount design)
<p>G00841</p>	<p>G00842</p>	<p>G00797</p>
Type 1 pipe component: Wafer type	Type 2 pipe component: Measuring section	Weld-on adapter DN 100 (4") and higher
<p>G00798</p>	<p>G00799</p> <p>optional with integrated flow straightener</p>	<p>G00800</p>

EN 1092-1 form B1, PN 40										
Nominal diameter			L2	h	D1	d1	d2	D4	L3	L4
DN 25	B1 = 125 (4.92)		269 (10.59)	263 (10.35)	-	28.5 (1.12)	-	115 (4.53)	600 (23.62)	486 (19.13)
DN 40	B2 = 80 (3.15)				94 (3.70)	43.1 (1.70)	88 (3.46)	150 (5.91)	860 (33.86)	731 (28.78)
DN 50	B3 = Ø115 (4.53)				109 (4.29)	54.5 (2.15)	102 (4.02)	165 (6.50)	1000 (39.37)	837 (32.95)
DN 65	B4 = 58 (2.28)				129 (5.08)	70.3 (2.77)	122 (4.80)	185 (7.28)	1400 (55.12)	1190 (46.85)
DN 80	K1 = 150 (5.91)				144 (5.67)	82.5 (3.25)	138 (5.43)	200 (7.87)	1700 (66.93)	1450 (57.09)
DN 100	K3 = 206 (8.11)				170 (6.69)	107.1 (4.22)	162 (6.38)	235 (9.25)	2200 (86.61)	1870 (73.62)
DN 125	L1 = 188 (7.40)				196 (7.72)	131.7 (5.19)	188 (7.40)	270 (10.63)	2700 (106.3)	2300 (90.55)
DN 150	L5 = 450 (17.72)				226 (8.90)	159.3 (6.27)	218 (8.58)	300 (11.81)	3200 (125.98)	2720 (107.09)
DN 200	L6 = 310 (12.20)				293 (11.54)	206.5 (8.13)	285 (11.22)	375 (14.76)	4200 (165.35)	3580 (140.94)
> 350	L7 = 65 (2.56)				431 (16.97)	425 (16.73)				
> 700	M1 = 208 (8.19)		781 (30.75)	775 (30.51)						
	M2 = 265 (10.43)									
	M3 = 139 (5.47)									
ASME B 16.5, Cl. 150 (ANSI), Sch 40 S										
1"	B1 = 125 (4.92)		269 (10.59)	263 (10.35)	-	26.6 (1.05)	-	108 (4.25)	560 (22.05)	454 (17.87)
1 1/2"	B2 = 80 (3.15)				85 (3.35)	40.9 (1.61)	73 (2.87)	127 (5.00)	864 (34.02)	741 (29.17)
2"	B3 = Ø115 (4.53)				103 (4.06)	52.6 (2.07)	92 (3.62)	154 (6.06)	1003 (39.49)	846 (33.31)
3"	B4 = 58 (2.28)				135 (5.31)	78.0 (3.07)	127 (5.00)	-	-	-
4"	K1 = 150 (5.91)				173 (6.81)	102.4 (4.03)	157 (6.18)	-	-	-
6"	K3 = 206 (8.11)				221 (8.70)	154.2 (6.07)	216 (8.50)	-	-	-
8"	L1 = 188 (7.40)				278 (10.94)	202.7 (7.98)	270 (10.63)	-	-	-
> 14"	L5 = 450 (17.72)				431 (16.97)	425 (16.73)				
> 28"	L6 = 310 (12.20)				781 (30.75)	775 (30.51)				
	L7 = 65 (2.56)									
	M1 = 208 (8.19)									
	M2 = 265 (10.43)									
	M3 = 139 (5.47)									

Dimensions in mm (inch)

ASME B 16.5, Cl. 300 (ANSI), Sch 40 S									
1"	B1 = 125 (4.92)	269 (10.59)	263 (10.35)	-	26.6 (1.05)	-	123.9 (4.88)	560 (22.05)	454 (17.87)
1 1/2"	B2 = 80 (3.15)			94 (3.70)	40.9 (1.61)	73 (2.87)	155.4 (6.12)	864 (34.02)	741 (29.17)
2"	B3 = Ø115 (4.53)			110 (4.33)	52.6 (2.07)	92 (3.62)	165.1 (6.50)	1003 (39.49)	846 (33.31)
3"	B4 = 58 (2.28)			148 (5.83)	78.0 (3.07)	127 (5.00)	-	-	-
4"	K1 = 150 (5.91)			180 (7.09)	102.4 (4.03)	157 (6.18)	-	-	-
6"	L1 = 188 (7.40)			249 (9.80)	154.2 (6.07)	216 (8.50)	-	-	-
8"	L5 = 450 (17.72)			307 (12.09)	202.7 (7.98)	270 (10.63)	-	-	-
> 14"	L6 = 310 (12.20)	431 (16.97)	425 (16.73)						
> 28"	L7 = 65 (2.56)	781 (30.75)	775 (30.51)						
	M1 = 208 (8.19)								
	M2 = 265 (10.43)								
	M3 = 139 (5.47)								

Dimensions in mm (inch)

## 7 Installation instructions

### 7.1 Weld-on adapter for Sensyflow FMT500-IG

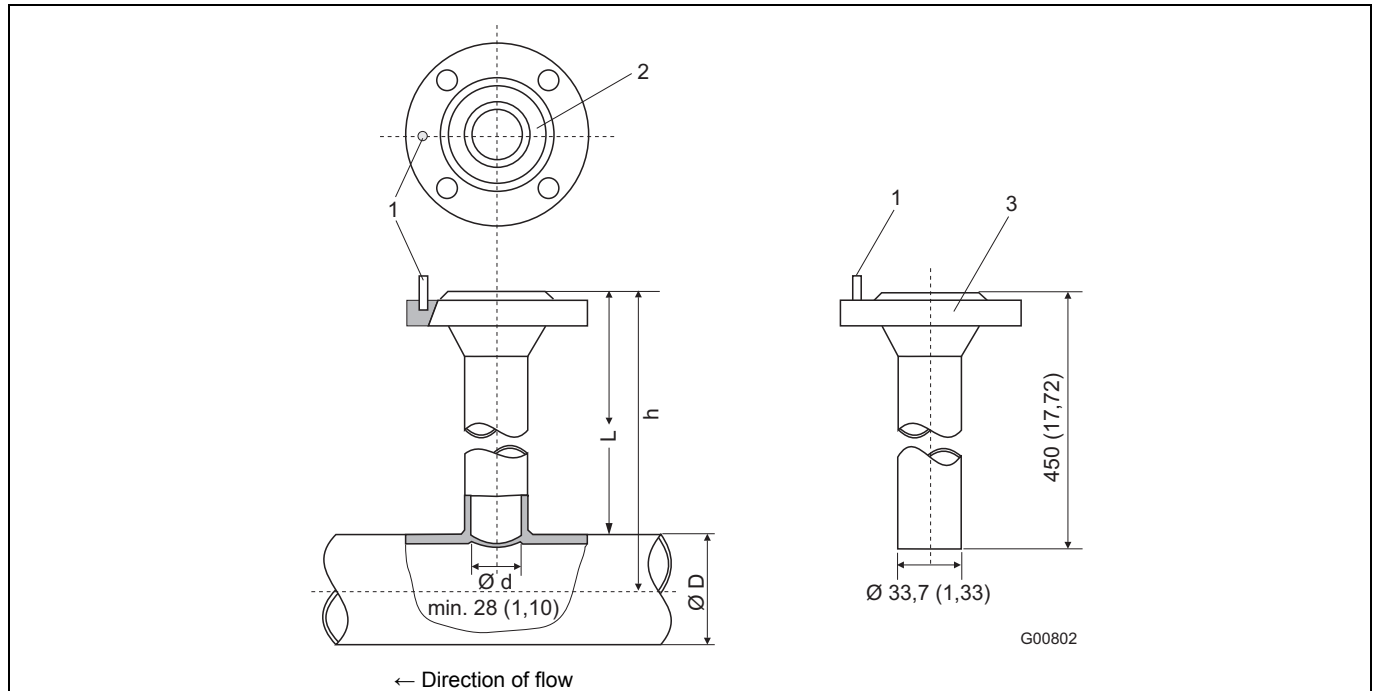

Fig. 6: Dimensions in mm (inch)

- |                       |                                |
|-----------------------|--------------------------------|
| 1 Centering pin       | 3 Connection flange DN 25 (1") |
| 2 Sealing ring groove | D Outer pipe diameter          |

Flowmeter sensor length h in mm (inch)	Outer pipe diameter min. / max. in mm (inch)
263 (10.35)	100 ... 350 (3.94 ... 13.78)
425 (16.73)	> 350 ... 700 (13.78 ... 27.56)
775 (30.51)	> 700 ... 1400 (27.56 ... 55.12) <sup>1)</sup>

<sup>1)</sup> This maximum pipe diameter specification is only valid when installing the sensor unit centrally in the pipe. For larger diameters or angular ducts a non-centric sensor position is taken into account for calibration.



#### IMPORTANT (NOTE)

Prior to mounting the weld-on adapters must be shortened to length:  $L = h - 1/2 D_{\text{outer}}$ .

The distance h between the upper flange edge and the pipe center line must be within a tolerance of  $\pm 2$  mm (0.08").

The right angle to the pipe center line must be observed (max. tolerance  $\pm 2^\circ$ ).

The centering pin of the adapter must be aligned centrally with the pipe center line in flow direction (on outlet run side, downstream of the measuring point).

## 7.2 Weld-on adapter with ball valve for Sensyflow FMT500-IG

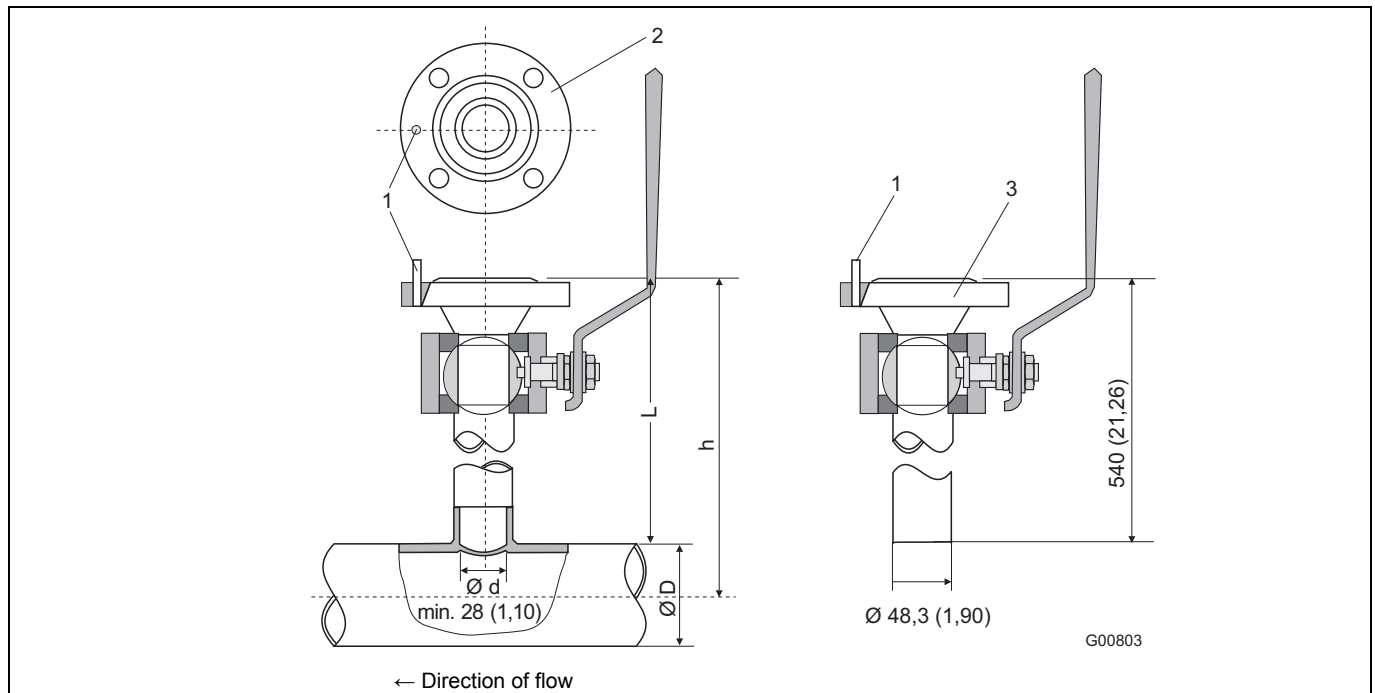

Fig. 7: Dimensions in mm (inch)

- |                       |                                |
|-----------------------|--------------------------------|
| 1 Centering pin       | 3 Connection flange DN 25 (1") |
| 2 Sealing ring groove | D Outer pipe diameter          |

Flowmeter sensor length h in mm (inch)	Outer pipe diameter min. / max. in mm (inch)
263 (10.35)	100 ... 150 (3.94 ... 5.91)
425 (16.73)	> 150 ... 500 (5.91 ... 19.69)
775 (30.51)	> 500 ... 1150 (19.69 ... 45.28) <sup>1)</sup>

1) This maximum pipe diameter specification is only valid when installing the sensor unit centrally in the pipe. For larger diameters or angular ducts a non-centric sensor position is taken into account for calibration.



### IMPORTANT (NOTE)

Prior to mounting the weld-on adapters must be shortened to length:  $L = h - 1/2 D_{\text{outer}}$ .

The distance h between the upper flange edge and the pipe center line must be within a tolerance of  $\pm 2$  mm (0.08").

The right angle to the pipe center line must be observed (max. tolerance  $\pm 2^\circ$ ).

The centering pin of the adapter must be aligned centrally with the pipe center line in flow direction (on outlet run side, downstream of the measuring point).

### 7.3 Integrated hot tap fitting for Sensyflow FMT500-IG

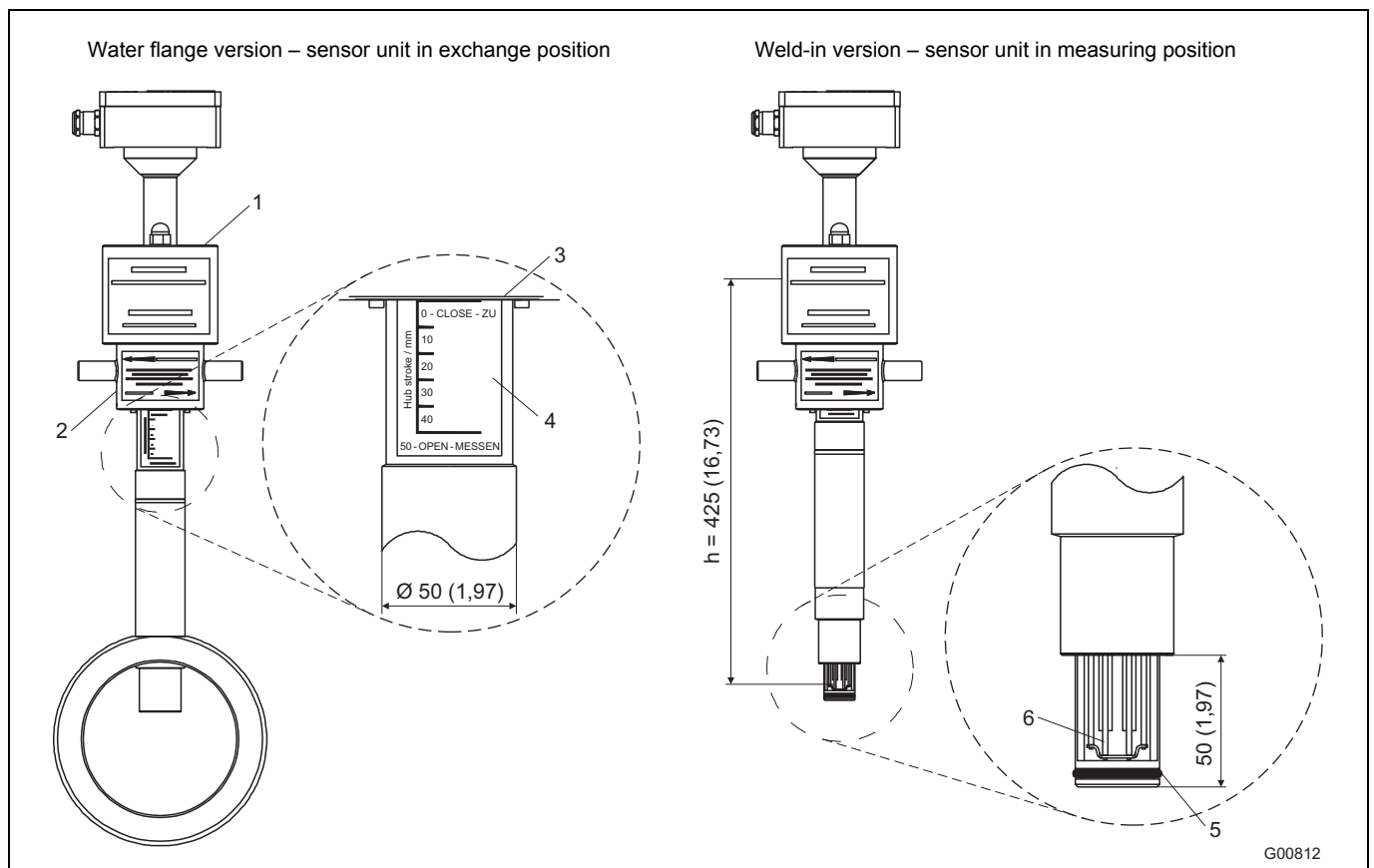

Fig. 8: Dimensions in mm (inch)

- |  |  |
|--|--|
| <ul style="list-style-type: none"> <li>1 Covers for DN 25 flange</li> <li>2 Spigot nut</li> <li>3 Bottom edge of spigot nut</li> </ul> | <ul style="list-style-type: none"> <li>4 Display of sensor unit position, 50 mm (1,97") stroke</li> <li>5 Sealing ring</li> <li>6 Sensor elements</li> </ul> |
|--|--|

Flowmeter sensor length h	
Water flange version	Weld-in version
h = 263 mm (10.35") for DN 50, DN 65 and DN 80 / 2", 3" h = 425 mm (16.73") for DN 100, DN 125, DN 150 and DN 200 / 4", 6", 8"	h = always 425 mm (16.73")

The integrated hot tap fitting is used instead of the pipe component and weld-on adapter assembly described above if the flowmeter sensor must be exchangeable during operation with virtually no gas escaping from the system.

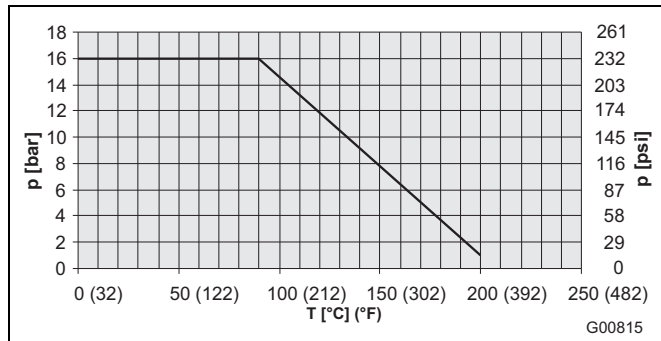

Fig. 9: Maximum pressure/temperature values for the integrated hot tap fitting

It is recommended to use the hot tap fitting for measurements in main conduits (e.g. compressed air systems) or for measuring points which otherwise require rinsing prior to removing the flowmeter sensor. As a rule, hot tap fittings should be preferred for all systems where, otherwise, the entire system or parts of it must be switched off to replace a flowmeter sensor.

**Handling:**

The flowmeter sensor is screwed to the hot tap fitting through the DN 25 flange. Then the cover is put on. The sensor unit is set from the exchange position to the measuring position by turning the spigot nut. The bottom edge of the spigot nut indicates the current sensor unit position (see Detail A, sensor unit is in exchange position). Only when the measuring position 50 – OPEN - MESSEN (lower stop of the spigot nut) is reached, the sensor elements are placed exactly in the center of the pipe and exact measurement is ensured.

**i IMPORTANT (NOTE)**

For integrated hot tap fitting in wafer flange design DN 65, use connection flange PN16 with 4 screw holes on the process side. Wafer flange versions 2 ... 8" only for connection flange ASME B16.5 Cl.150.

## 8 Recommended steadying lengths according to DIN EN ISO 5167-1

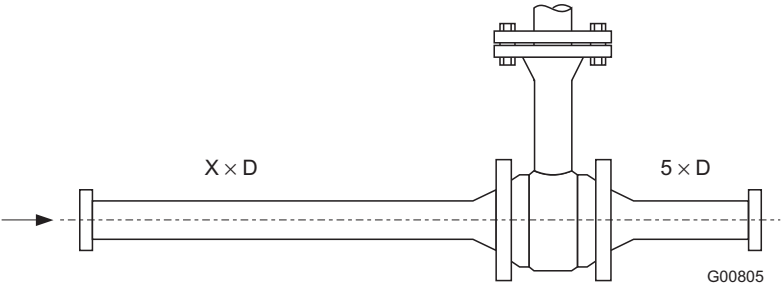
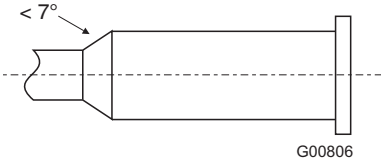
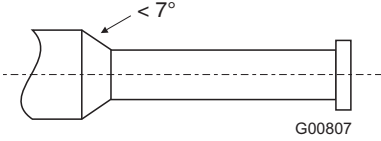
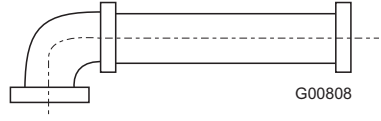
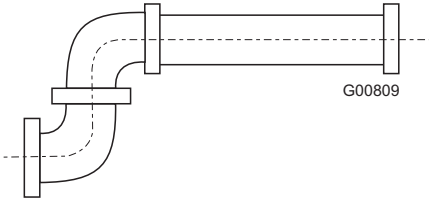
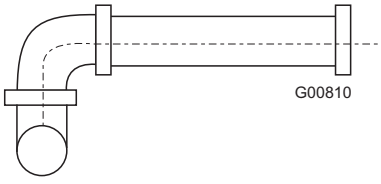
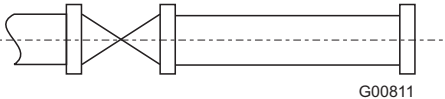
	
	<p>Expansion <math>X = 15</math></p>
	<p>Reducer <math>X = 15</math></p>
	<p>90° elbow <math>X = 20</math></p>
	<p>Two 90° elbow in one level <math>X = 25</math></p>
	<p>Two 90° elbow in two levels <math>X = 40</math></p>
	<p>Valve / slide <math>X = 50</math></p>

To achieve the stated measuring accuracy, the steadying lengths seen above must be provided. For combinations of inlet run disturbances, e. g. valve and reducer, you must always consider the longer inlet run length. In confined spaces at the mounting location the outlet run length can be shortened to  $3 \times D$ . The reduction of the minimum inlet run length, however, will impact on the achievable accuracy.

High repeatability of the measuring value is still provided. Under certain circumstances, special calibration can be performed for insufficient steadying lengths. For this purpose and in individual cases consulting is necessary.

For gases with extremely low density (hydrogen, helium) the steadying lengths must be doubled.



## 9 Ordering information

	Version number	Main order number											Add. order no.				
		7	8	9	10	11	12	13	14	15	16						
<b>Sensyflow FMT500-IG Thermal Mass Flowmeter, for gases, intelligent</b>	V14224	X	X	X	X	X	X	X	X	X	X	X	X	X	X	XXX	
<b>Version</b>																	
Standard, -25 ... 150 °C (-13 ... 302 °F)		1															
High temperature version, -25 ... 300 °C (-13 ... 572 °F)		2															
ATEX version for Zone 2 / 22, -20 ... 150 °C (-4 ... 302 °F)	1)	3															
ATEX version for Zone 1 / 21, -20 ... 150 °C (-4 ... 302 °F)	2)	4															
ATEX version for Zone 0 / 21, -20 ... 80 °C (-4 ... 176 °F)		5															
FM / CSA version Cl. 1 Div 2, -20 ... 150 °C (-4 ... 302 °F) (remote version only)		6															
FM / CSA version Cl. 1 Div 1 / 2, -20 ... 150 °C (-4 ... 302 °F) (compact version only)		7															
GOST Russia, Ex Zone 1 / 21, -20 ... 150 °C (-4 ... 302 °F)		A															
GOST Russia, Ex Zone 0 / 21, -20 ... 80 °C (-4 ... 176 °F)		B															
GOST Kazakhstan, Ex Zone 1 / 21, -20 ... 150 °C (-4 ... 302 °F)		C															
GOST Kazakhstan, Ex Zone 0 / 21, -20 ... 80 °C (-4 ... 176 °F)		D															
GOST Ukraine, Ex Zone 1 / 21, -20 ... 150 °C (-4 ... 302 °F)		E															
GOST Ukraine, Ex Zone 0 / 21, -20 ... 80 °C (-4 ... 176 °F)		F															
GOST Belarus, Ex Zone 1 / 21, -20 ... 150 °C (-4 ... 302 °F)		G															
GOST Belarus, Ex Zone 0 / 21, -20 ... 80 °C (-4 ... 176 °F)		H															
<b>Measured medium</b>																	
Gases, gas mixtures and natural gas (with max. 23.5 Vol% O2 each)		A															
Oxygen / gas mixtures > 23.5 Vol% O2, oil and grease-free, with O2 certificate (max. 150 °C / 302 °F)		B															
Natural gas, with DVGW certificate (max. 80 °C / 176 °F)		C															
Hydrogen, Helium (max. 8 bar / 0.8 MPa / 116 psi, always with process gas calibration)	3)	D															
Ammonia Application		E															
<b>Sensor unit</b>																	
Ceramic sensor																	1
<b>Mounting Length / Material</b>																	
263 mm (10.4 in.) / AISI 316Ti SST (1.4571) (DN 25 ... DN 350 [1 ... 14 in.])																	4) 1
425 mm (17 in.) / AISI 316Ti SST (1.4571) (> DN 350 ... DN 700 [> 14 ... 28 in.])																	4) 2
775 mm (31 in.) / AISI 316Ti SST (1.4571) (> DN 700 [> 28 in.])																	4) 3
<b>Power supply</b>																	
Universal power supply 110 ... 230 V AC / DC																	5) 1
Low voltage power supply 24 V AC / DC																	6) 2
<b>Design</b>																	
Compact design with display, controlled via magnetic pen and keypad																	1
Remote design with display, controlled via magnetic pen and keypad (for required cable see accessories)																	7) 2
<b>Communication</b>																	
Analog signal 4 ... 20 mA / HART, alarm < 3.5 mA																	1
Analog signal 4 ... 20 mA / HART, alarm > 22 mA																	4
Analog signal 0 ... 20 mA / HART																	5
PROFIBUS DPV1, direct connection of bus cable																	2
PROFIBUS DPV1, with DP M12 connector socket																	8) 3
<b>Cable gland</b>																	
M20 x 1.5																	1
1/2 in. NPT																	2
<b>Number of Characteristic Curves</b>																	
1 characteristic curve																	1
2 characteristic curves																	2
3 characteristic curves																	3
4 characteristic curves																	4
<b>Certificates: Calibration</b>																	
Factory certificate																	0
DAkS certificate, calibration with air (not for process gas calibration)																	9) 1

Continued on next page

	Version number	Main order number											Add. order no.				
		1	2	3	4	5	6	7	8	9	10	11		12	13	14	15
<b>Sensyflow FMT500-IG Thermal Mass Flowmeter, for gases, intelligent</b>	<b>V14224</b>	X	X	X	X	X	X	X	X	X	X	X	X	X	X	X	<b>XXX</b>
<b>Certificates and Material Traceability</b>																	
Material certificate 3.1 acc. EN 10204																	CBB
Declaration of compliance with the order 2.1 acc. EN 10204																	CF3
<b>Certificates: GOST, SIL</b>																	
GOST Russia - metrological approval																	CG1
GOST Kazakhstan - metrological approval																	CG2
SIL1 - Declaration of Conformity																	CS1
<b>Signal cable length</b>																	
5 m (approx. 15 ft)																10)	SC1
15 m (approx. 45 ft)																10)	SC3
25 m (approx. 75 ft)																10)	SC5
<b>Language of documentation</b>																	
German																	M1
English																	M5
Russian																	MB
Language package Western Europe / Scandinavia (languages: DE, EN, DA, ES, FR, IT, NL, PT, FI, SV)																	MW
Language package Eastern Europe (languages: DE, EL, CS, ET, LV, LT, HU, PL, SK, SL, RO, BG)																	ME

Accessories	Order number
FMT500-IG Special cable between flowmeter sensor and transmitter, cable length 5 m	7962844
FMT500-IG Special cable between flowmeter sensor and transmitter, cable length 15 m	7962845
FMT500-IG Special cable between flowmeter sensor and transmitter, cable length 25 m	7962846
FMT500-IG PROFIBUS DP-T connector plug	7962847
FMT500-IG PROFIBUS DP socket, for customizing the bus cable	7962848
FMT500-IG PROFIBUS DP connector, for customizing the bus cable	7962849
FMT500-IG Documentation CD-ROM	3KXF421002R0800
FMT500-IG Commissioning Instruction, English	3KXF421008R4401
FMT500-IG Commissioning Instruction, German	3KXF421008R4403
FMT500-IG Commissioning Instruction, Language package Eastern Europe	3KXF421008R4494
FMT500-IG Commissioning Instruction, Language package Western Europe / Scandinavia	3KXF421008R4493
FMT500-IG Operating Instruction, Russian	3KXF421008R4222
FMT500-IG SIL-Safety Instructions, English	3KXF421000R4801
FMT500-IG SIL-Safety Instructions, German	3KXF421000R4803

- 1) Manufacturer's declaration
- 2) The max. allowed gas temperature / process temperature depends on the temperature class: T1 / T2 max. 150 °C (302 °F), T3 / T4 max. 100 °C (212 °F)
- 3) With measuring medium H2 or He, lower measuring range limit typical 10% of upper limit, in nominal size DN 25 ... DN 50 (1 ... 2 in.):  
Please use pipe component design 2 with flow straightener
- 4) Nominal size ranges when using pipe components or weld-on adapters without ball valve
- 5) +/- 10 % (f = 48 ... 62 Hz)
- 6) +/- 20 % (f = 48 ... 62 Hz)
- 7) With ATEX versions: wall housing with operating electronics can be mounted in Ex zone 2
- 8) For non-Ex / compact versions only
- 9) DAKS- / ILAC-accredited calibration equipment D-K-15081-01-00
- 10) Only for Remote Version

	Main order number										Add. order no.	
	Version number	1 - 6	7-9	10	11	12	13	14	15			
<b>FMT081 pipe component / weld-on adapter, for Sensyflow FMT500-IG and FMT400-VTS</b>	<b>FMT081</b>		<b>XXX</b>	<b>X</b>	<b>X</b>	<b>X</b>	<b>X</b>	<b>X</b>	<b>X</b>	<b>X</b>		<b>XXX</b>
<b>Mounting Length of the Sensor</b>												
263 mm (10.4 in.)			263									
425 mm (17 in.)			425									
775 mm (31 in.)			775									
<b>Measuring Medium</b>												
Gases, gas mixtures, and natural gas (each max. 23.5 vol% O <sub>2</sub> )				<b>A</b>								
Oxygen / gas mixtures > 23.5 Vol% O <sub>2</sub> , oil and grease-free, with O <sub>2</sub> certificate (max. 150 °C / 302 °F)				<b>B</b>								
Natural gas, with DVGW certificate (max. 80 °C / 176 °F)				<b>C</b>								
Hydrogen, Helium				<b>1) D</b>								
<b>Design</b>												
Pipe component 1 in wafer flange version					<b>1</b>							
Pipe component design 2 as partial measuring section					<b>2</b>							
Pipe component design 2 as partial measuring section with integrated flow straighteners						<b>3</b>						
Weld-on adapter				<b>2)</b>	<b>4</b>							
Other					<b>9</b>							
<b>Nominal Diameter</b>												
Selection for weld-on adapter							<b>Y</b>					
DN 25 (1 in.)					<b>3)</b>		<b>A</b>					
DN 40 (1-1/2 in.)					<b>4)</b>		<b>C</b>					
DN 50 (2 in.)							<b>D</b>					
DN 65 (2-1/2 in.)						<b>5)</b>	<b>E</b>					
DN 80 (3 in.)						<b>6)</b>	<b>F</b>					
DN 100 (4 in.)						<b>6)</b>	<b>G</b>					
DN 125 (5 in.)						<b>6)</b>	<b>H</b>					
DN 150 (6 in.)						<b>6)</b>	<b>J</b>					
DN 200 (8 in.)						<b>6)</b>	<b>L</b>					
Other						<b>7)</b>	<b>Z</b>					
<b>Flange Style and Pressure Rating</b>												
Selection for weld-on adapter									<b>0</b>			
DIN PN 40, nominal pressure 40 bar (4 MPa / 580 psi)									<b>1</b>			
ANSI / ASME CL 150, Schedule 40 S									<b>2</b>			
ANSI / ASME CL 300, Schedule 40 S								<b>4)</b>	<b>3</b>			
Other									<b>9</b>			
<b>Process Connection for Flowmeter Sensor</b>												
Standard Sensyflow flange with centering pin							<b>8)</b>		<b>A</b>			
With ball valve, max. 150 °C (302 °F) and 16 bar (1.6 MPa / 232 psi)							<b>9)</b>		<b>G</b>			
With integrated hot tap fitting for max. DN 125 (5 in.). Allows gas-tight flowmeter sensor removal / insertion up to 16 bar (1.6 MPa / 232 psi) or 200 °C (392 °F). For DN 65, use connection flanges PN 16 with 4 screw holes (For pipe component DN 50 ... DN 80, apply Sensor Length h = 263 mm, from DN 100 and for weld-on adapter, apply Sensor Length h = 425 mm)							<b>10)</b>		<b>H</b>			
With integrated hot tap fitting above DN 125 (5 in.) to max. DN 200 (8 in.) / DN 300 (12 in.) with weld-on adapter. Allows gas-tight flowmeter sensor removal / insertion up to 16 bar (1.6 MPa / 232 psi) or 200 °C (392 °F) (Please apply the correct sensor length)							<b>11)</b>		<b>J</b>			
<b>Material</b>												
Stainless steel AISI 316Ti (1.4571)											<b>3</b>	
Carbon steel S 235 (1.0037)									<b>12)</b>	<b>1</b>		
Plastics PE-HD (Polyethylene high-density)									<b>12)</b>	<b>7</b>		
<b>Blind Flange</b>												
DN 25 blind flange to close flowmeter sensor connection, material stainless steel AISI 316Ti (1.4571)												<b>F3</b>
<b>Certificates and Material Traceability</b>												
Material certificate 3.1 acc. EN 10204												<b>CBB</b>
Declaration of compliance with the order 2.1 acc. EN 10204												<b>CF3</b>

Footnotes see next page

- 1) Max. 8 bar / 0.8 MPa / 116 psi. With DN 25 ... DN 50 (1 ... 2 in.): Please use pipe component 2 with flow straightener.
- 2) From DN 100 (4 in.).
- 3) Not available with pipe component 1 in wafer flange version.
- 4) Not available with hot-tap-fitting.
- 5) Not available with flange style ANSI / ASME.
- 6) Not available with pipe component 2 in combination with flange style ANSI / ASME.
- 7) Please specify exact inner pipe diameter.
- 8) Correct sensor length: For pipe component 1 and 2 without ball valve / hot tap fitting: h = 263 mm. For weld-on adapter and pipe diameter up to 350 mm: h = 263 mm, up to 700 mm: h = 425 mm, > 700 mm: h = 775 mm
- 9) Not available with DVGW certificate. Correct sensor length: For pipe component DN 50 ... DN 100: h = 263 mm, from DN 125: h = 425 mm. For weld-on adapter up to 150 mm: h = 263 mm, up to 500 mm: h = 425 mm, > 500 mm: h = 775 mm
- 10) Not available with DVGW certificate. Correct sensor length: For pipe component DN 50 ... DN 80: h = 263 mm, for pipe component from DN 100 and weld-on adapter: h = 425 mm.
- 11) Not available with DVGW certificate. Please apply the correct sensor length.
- 12) Only for weld-on adapter without ball-valve. Only without certificates.

## 9.1 Additional ordering information

FMT500-IG		
Gas component 1	Vol. %	(clear text, for max. 4 characteristics)
Gas component 2	Vol. %	(clear text, for max. 4 characteristics)
Gas component 3	Vol. %	(clear text, for max. 4 characteristics)
Gas component 4	Vol. %	(clear text, for max. 4 characteristics)
Gas component 5	Vol. %	(clear text, for max. 4 characteristics)
Gas component 6	Vol. %	(clear text, for max. 4 characteristics)
Gas component 7	Vol. %	(clear text, for max. 4 characteristics)
Gas component 8	Vol. %	(clear text, for max. 4 characteristics)
Gas component 9	Vol. %	(clear text, for max. 4 characteristics)
Gas component 10	Vol. %	(clear text, for max. 4 characteristics)
Summe 100 %		
Operating temperature		(clear text, for max. 4 characteristics)
Operating pressure		(clear text, for max. 4 characteristics)
Nominal size, Pipe inner diameter		(clear text, for max. 4 characteristics)
Measuring range		(clear text, for max. 4 characteristics)
Unit <sup>1)</sup>		(clear text, for max. 4 characteristics)
Standard conditions (e. g. 0 °C, 1013 mbar)		(clear text, for max. 4 characteristics)
Display and menu language (delivered state)		German, English, French, Portuguese
Material of the connected pipes		

- 1) Available flow rate units:

t/d	t/h	t/min	t/s
kg/d	kg/h	kg/min	kg/s
	g/h	g/min	g/s
lb/d	lb/h	lb/min	lb/s
Nm <sup>3</sup> /d	Nm <sup>3</sup> /h	Nm <sup>3</sup> /min	Nm <sup>3</sup> /s
NL/d	NI/h	NI/min	NI/s
SCFD	SCFH	SCFN	SCFS

10 Questionnaire

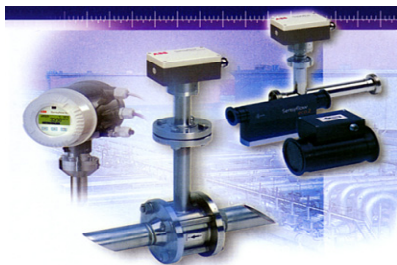

**Questionnaire**  
**Thermal Mass Flowmeter**  
**Sensyflow FMT**

**Customer address:** \_\_\_\_\_  
 Company: \_\_\_\_\_  
 Zip code and location: \_\_\_\_\_ Date: \_\_\_\_\_  
 Cust. no.: \_\_\_\_\_ Telephone: \_\_\_\_\_  
 Contact person: \_\_\_\_\_ E-mail: \_\_\_\_\_

**Media data for gaseous, pure media:**

Description of media Mixed gas, gas composition in vol.%<sup>1)</sup>

Type of gas (no mixtures): \_\_\_\_\_ Component 1/name/vol. %: \_\_\_\_\_  
 Operating pressure (bar abs.) \_\_\_\_\_ Component 2/name/vol. %: \_\_\_\_\_  
 Min./norm./max., approx. \_\_\_\_\_ Component 3/name/vol. %: \_\_\_\_\_  
 Operating temperature (°C) \_\_\_\_\_ Component 4/name/vol. %: \_\_\_\_\_  
 Min./norm./max., approx. \_\_\_\_\_ Component 5/name/vol. %: \_\_\_\_\_

**Flowrate**<sup>2)</sup> Min.: \_\_\_\_\_ Norm.: \_\_\_\_\_ Max.: \_\_\_\_\_ **Pipeline/pipe component**<sup>3)</sup>

**Flow unit:**

	<i>Standard volume</i>	<i>Mass flow units</i>	DN/PN: _____
Nm <sup>3</sup> /h	<input type="checkbox"/>	kg/h	<input type="checkbox"/>
Nm <sup>3</sup> /min	<input type="checkbox"/>	kg/min	<input type="checkbox"/>
NI/min	<input type="checkbox"/>	g/min	<input type="checkbox"/>
SCFM	<input type="checkbox"/>	t/h	<input type="checkbox"/>
Other _____		Other _____	

ANSI/lbs \_\_\_\_\_  
 Diameter [mm] \_\_\_\_\_  
*Inside diameter specified in mm*  
 Wafer flange form 1   
 Partial meas. section form 2   
 Weld-on adapter   
 Other \_\_\_\_\_

\*Standard condition, e.g., 0°C/1,013 mbar or \_\_\_\_\_

**Required device designs:**

FMT500-IG <input type="checkbox"/>	FMT700-P <sup>4)</sup> <input type="checkbox"/>	Integral mount design <input type="checkbox"/>
FMT400-VTS <input type="checkbox"/>	FMT200-ECO2 <input type="checkbox"/>	Remote design with
FMT400-VTCS <input type="checkbox"/>	FMT200-D <input type="checkbox"/>	Cable length 5 m <input type="checkbox"/>
		Cable length 15 m <input type="checkbox"/>
		Cable length 25 m <input type="checkbox"/>

**Output signal:**      **Ex protection class:**

0/4...20 mA <input type="checkbox"/>	None <input type="checkbox"/>	Zone 2/22 <input type="checkbox"/>	24 V <input type="checkbox"/>
4...20 mA/HART <input type="checkbox"/>	ATEX Zone 1/21 <input type="checkbox"/>	GOST <input type="checkbox"/>	110 V <input type="checkbox"/>
PROFIBUS DP-V1 <input type="checkbox"/>	ATEX Zone 0/21 <input type="checkbox"/>	FM/CSA <input type="checkbox"/>	230 V <input type="checkbox"/>

**Comments:**

---

1) Please specify the composition of mixed gases (e.g., North Sea natural gas: 1) CH<sub>4</sub> 90%, 2) C<sub>2</sub>H<sub>6</sub> 5%, 3) N<sub>2</sub> 3%, 4) C<sub>3</sub>H<sub>8</sub>, 1%, 5) CO<sub>2</sub> 1%).  
 2) Calibration is performed at the max. possible flow in the nominal size specified.  
 3) Please observe/determine the minimum inflow and outflow sections.  
 4) Output signal: 0...10 V as standard

**Note: An order can only be confirmed and a delivery date specified once full technical clearance has been obtained.**

Notes

Notes

# Contact us

## **ABB Limited**

### **Process Automation**

Oldends Lane, Stonehouse  
Gloucestershire, GL10 3TA  
UK

Tel: +44 (0)1453 826661

Fax: +44 (0)1453 829671

## **ABB Inc.**

### **Process Automation**

125 E. County Line Road  
Warminster, PA 18974  
USA

Tel: +1 215 674 6000

Fax: +1 215 674 7183

measurement@us.abb.com

## **ABB Automation Products GmbH**

### **Process Automation**

Dransfelder Str. 2  
37079 Goettingen  
Germany

Tel: +49 551 905-534

Fax: +49 551 905-555

[www.abb.com](http://www.abb.com)

## Note

We reserve the right to make technical changes or modify the contents of this document without prior notice. With regard to purchase orders, the agreed particulars shall prevail. ABB does not accept any responsibility whatsoever for potential errors or possible lack of information in this document.

We reserve all rights in this document and in the subject matter and illustrations contained therein. Any reproduction, disclosure to third parties or utilization of its contents - in whole or in parts - is forbidden without prior written consent of ABB.

Copyright© 2012 ABB

All rights reserved

3KXF421001R1001



Sales



Service



Software