

ABB MEASUREMENT & ANALYTICS | DATA SHEET

C1900 series

Circular chart recorder



Measurement made easy

A rugged, reliable recorder with the full capability to meet your needs

1 to 4 pen recording

- full application flexibility

NEMA 4X/IP66 construction

- hose-down protection

Analog, relay outputs, digital inputs and transmitter power supply as standard

- range of inputs and outputs built-in

Multiple indicator panels

- continuous display of all signal values

0.1% measurement accuracy

- precise process information

High noise immunity

- robust, dependable operation

RS485 Modbus serial communications

- open system compatibility

Totalizers and math functions built-in

- fully integrated solutions

C1900

The C1900 is a fully programmable circular chart recorder for up to four process signals. The C1900's straightforward operator controls and robust construction make it suitable for a variety of industrial environments. Excellent standard facilities are complemented by a powerful range of options to give the flexibility to match your application.

Comprehensive Process Information

The C1900 lets you see the status of your process at a glance: high visibility 6-digit displays provide a clear indication of up to four process values simultaneously and active alarms are signalled by flashing LEDs below the main display.



The chart is easily set up to show the information you need in the way you want. Pen ranges are individually set to give the best resolution for each signal; the time per revolution can be selected between 1 hour and 32 days. Additionally a true time event pen facility enables one pen to be set up as a 3-position event marker on the same time line as Pen 1.

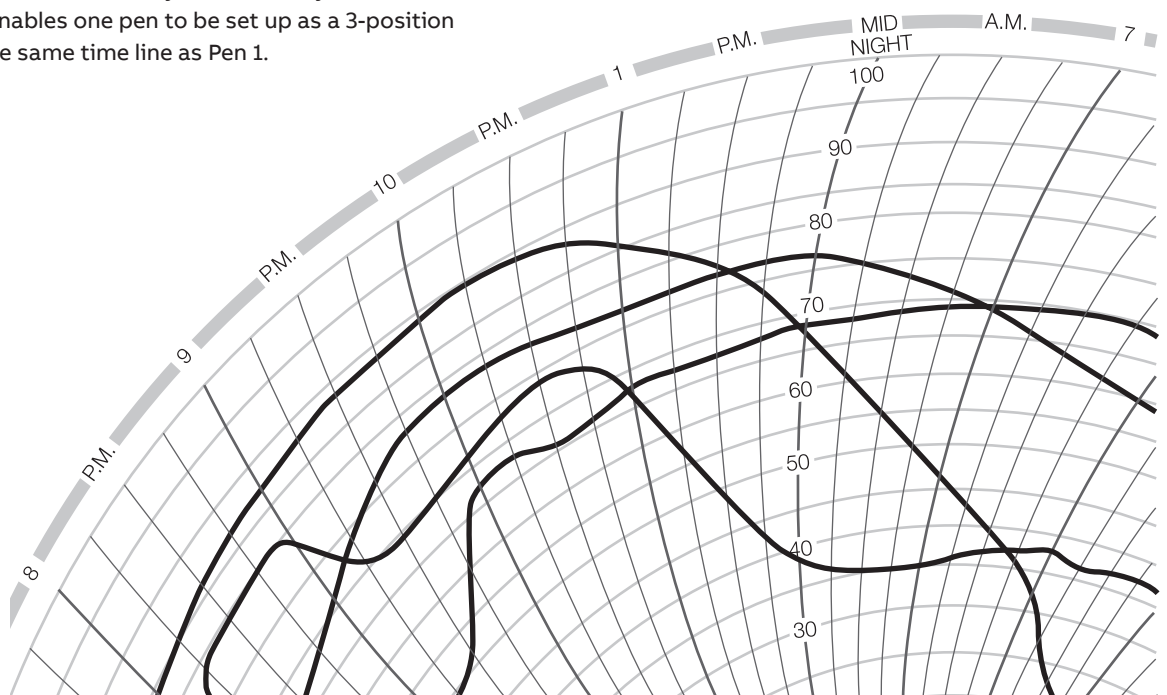

Simple Operation



The clearly-labelled tactile keypad gives direct access for operator adjustments and configuration programming, without the need to open the recorder's door. Clear text prompts on the digital displays guide the user around the various menus. A password-protected security system prevents unauthorized access to configuration adjustment menus.

Flexibility to Solve Problems

The C1900 offers seamless integration of loop functionality to solve process problems, eliminating the need for auxiliary devices.

Totalizers, Math And Logic

Integrating fluid flow to calculate total volume is performed by the built-in totalizers available for each channel. Relays can be assigned to increment or reset external counters to match the recorder's totalizer values.

User configurable math functions, mass flow calculations and RH tables are all fully supported.

Logic capability allows interlocking and integration of discrete and continuous functions to solve a wide range of process problems.

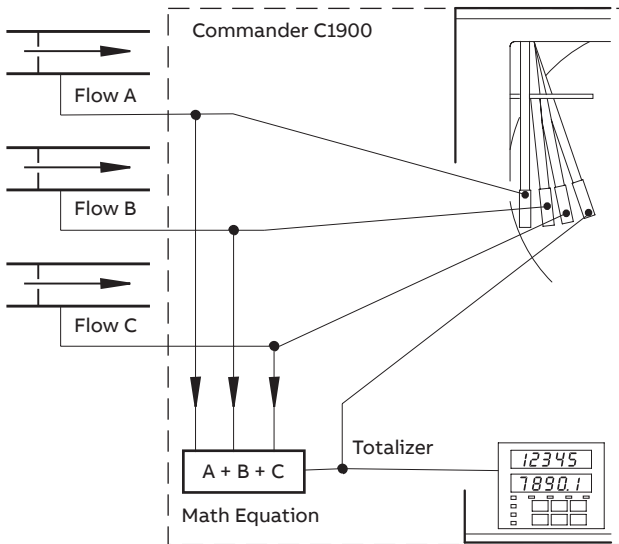

Summation of Three Flows

Timers and Clock

The C1900 offers two event timers driven by the recorder's real-time clock. The timers can be configured to operate relays, start/stop the chart or trigger other actions within the recorder.

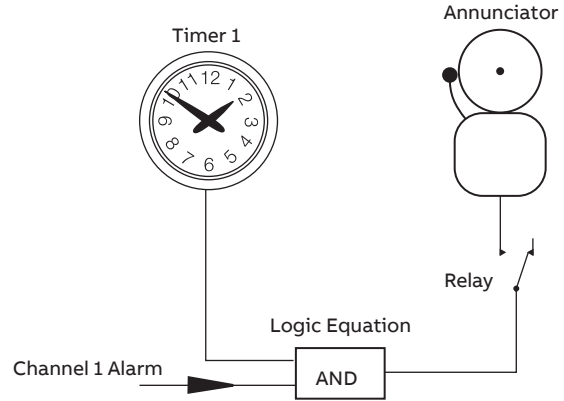

Alarm annunciation enabled during night hours only

Modbus RS485 Communications

Communications with PCs or PLCs are achieved via the RS485 serial communications link, enabling the C1900 to serve as the front end of plant-wide data acquisition systems. Using Modbus RTU protocol all process inputs and other variables can be continuously read by a host PC running any of a wide variety of standard SCADA packages.

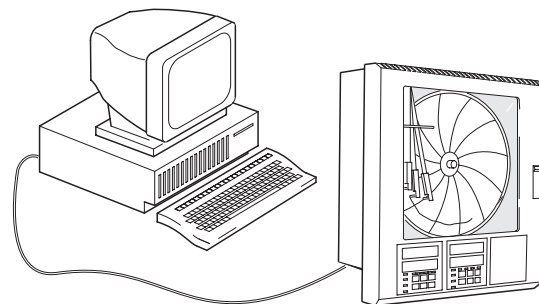

Built to Meet Your Needs

The C1900's modular architecture gives rise to a high level of hardware choice: up to five I/O modules can be added to the basic instrument.

The standard input/output module supplied with every pen comes complete with a fully isolated analog input, a relay output, transmitter power supply, isolated analog retransmission and two digital inputs.

Further input and output capability is provided by a range of plug-in modules:

- Analog input and relay – for use with math functions
- Four relays – channel alarm outputs
- Eight digital inputs – linked using logic equations
- Eight digital outputs – TTL level alarm outputs
- Modbus RS485 communications – interfaces with PCs

Expandable for the Future

The C1900 may be quickly upgraded to meet your changing process requirements.

Additional recording channels, math capability or input and output functions can be retrofitted on-site using plug-in cards and easily fitted pen arms. Input calibration data is stored on each card, allowing quick changes to input cards without the need for recalibration.

Changes to input sensors or recording procedures are accommodated by reconfiguration using the main keypad.

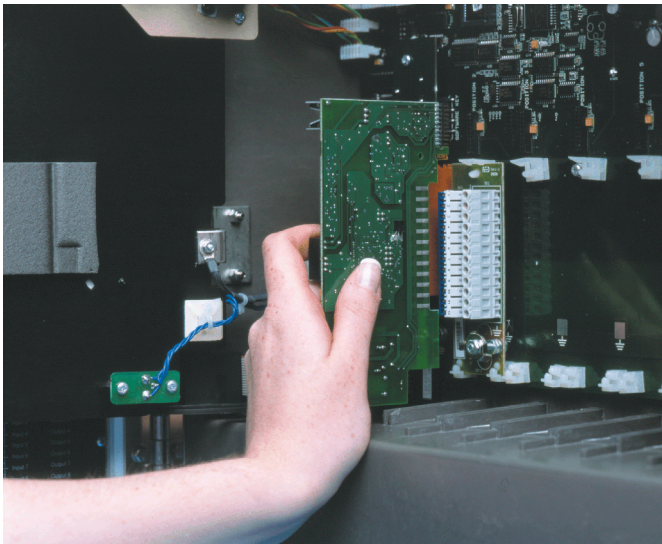

Designed to Survive

NEMA 4X protection ensures the C1900 can survive in the harshest environments and makes the recorder ideal for use in panels which are regularly hosed down. The tough, acid-resistant case and secure cable-entry glands maintain the NEMA 4X rating for wall-mounted or pipe-mounted instruments.

Noise Immunity

Recording accuracy is maintained in noisy industrial environments due to the advanced EMC shielding within the recorder. The power supply has been designed to give excellent protection from power spikes and brownouts and all configuration and status information is held in nonvolatile memory to ensure rapid recovery after a power failure.

Minimal Maintenance

Excellent long-term stability keeps recalibration to a minimum, cutting the costs of ownership. User-selectable chart speeds and long-life pens combine to limit usage of consumables.

Built-in Quality

The C1900 is designed, manufactured and tested to the highest quality standards, including ISO 9001.

Easy to Install

A choice of mounting options enables simple installation of the recorder in a panel, on a wall or on a pipe. Detachable terminal blocks allow for trouble-free connection of input and output wiring, with mains isolation provided by a power switch within the instrument.

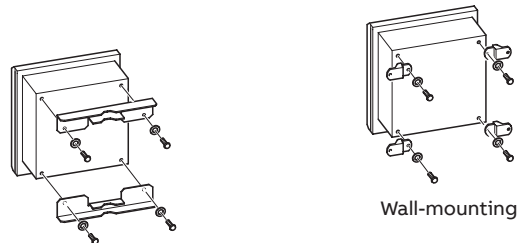

Wall-mounting

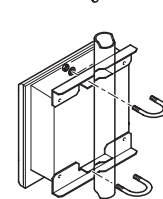

Pipe-mounting

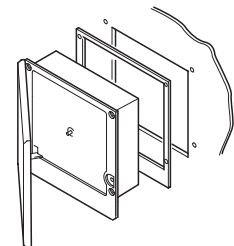

Panel-mounting

Summary

1, 2, 3 or 4 pens

10 in. chart size

Standard I/O with each pen includes:

- Analog input, analog output, transmitter power supply, relay output and 2 digital inputs.

Specification

General

Construction

Size	15.23 in. (h) × 15.04 in. (w) × 5.57 in. (d) (386.8 × 382.0 × 141.5mm)
Weight	18lb (8.2kg)
Case material	Glassfiber-filled reinforced polyester
Window material	Polycarbonate
Door latch	High-compression with optional lock

Environmental

Operational temperature range	0° to 55°C (32° to 130°F)
Operational humidity range	5 to 95%RH (non-condensing) 5 to 80%RH (chart only)
Case sealing	NEMA 4X (IP66)
Fast transients	IEC 801-4 Level 3

Installation

Mounting options	Panel, wall or pipe
Terminal type	Screw
Wire size (max.)	14 AWG (I/O), 12 AWG (power)

Operation and Configuration

Programming method	Via front panel keys
Security	Password-protected menus

Safety

General safety	IEC348
Dielectric	500V DC (channel/channel) 2kV DC (channel/ground)
Memory protection	Nonvolatile EEPROM
Approvals	CSA UL CSA/FM Class 1 Div. 2 CE

Power Supply

Voltage	100 to 240V AC ±10% (90V min. to 264V max. AC), 50/60 Hz
Consumption	<30VA (typical for full spec. unit)
Line interruption	Up to 60ms

Process Inputs And Outputs

General

Noise rejection	Common mode >120 dB at 50/60 Hz Normal (series) mode >60dB at 50/60 Hz
CJC rejection ratio	<0.05°C/°C
Sensor break protection	Upscale or downscale drive
Out of range detection	0 to 100% of engineering span
Temperature stability	<0.02% of reading/°C or 1 μV/°C
Long-term drift	<0.01% of reading 10 μV annually
Input impedance	>10MΩ (mV and V inputs) 39Ω (mA inputs)

Analog Outputs

Type	4 to 20mA
Accuracy	± 0.1%
Maximum load	750W
Dielectric	500V DC

Relay Outputs

Type	SPDT
Rating (with non-inductive load)	5A at 115/230V AC

Digital Inputs

Type	TTL or volt-free
Minimum pulse	250 ms
Dielectric	50V DC between modules, no isolation within module

Analog Inputs

Signal types	mV, V, mA, Ω
Thermocouple types	B, E, J, K, N, R, S, T
Resistance Thermometer	Pt100
Other linearizations	$x^{1/2}$, $x^{3/2}$, $x^{5/2}$, linear
Sample interval	250ms per channel
Dielectric	500V DC channel/channel
Digital filter	0 to 60s programmable

Digital Outputs

Type	5V TTL
Rating	5mA per output
Dielectric	500V DC between modules, no isolation within module

Serial Communications

Connections	RS485, 4-wire
Protocol	Modbus RTU

2-Wire Transmitter Power Supply

Number	1 per channel
Voltage	24V DC nominal
Drive	Up to 25 mA
Isolation	500V DC channel/channel

Analog input performance

Type	Range Lo	Range Hi	Min. Span	Accuracy
mV	0	150	5	±0.1% reading or 10μV
V	0	5	0.1	±0.1% reading or 20mV
mA	0	50	1	±0.2% reading or 0.2μA
Ohms (high)	0	750	20	±0.2% reading or 0.1W
Ohms (low)	0	10k	400	±0.5% reading or 10W

Type	°C		°F		Accuracy (excl. CJC)
	Range Lo	Range Hi	Range Lo	Range Hi	
B	-18	1800	0	3270	± 2 °C (above 200 °C) (3.6 °F above 434 °F)
E	-100	900	-140	1650	± 0.5 °C (± 0.9 °F)
J	-100	900	-140	1650	± 0.5 °C (± 0.9 °F)
K	-100	1300	-140	2350	± 0.5 °C (± 0.9 °F)
N	-200	1300	-325	2350	± 0.5 °C (± 0.9 °F)
R	-18	1700	0	3000	± 1 °C (above 300 °C) (1.8 °F above 572 °F)
S	-18	1700	0	3000	± 1 °C (above 200 °C) 1.8 °F above 572 °F)
T	-250	300	-400	550	± 0.5 °C (± 0.9 °F)
PT100	-200	600	-325	1100	± 0.5 °C (± 0.9 °F)

...Specification

Recording System

Pens

Number	1, 2, 3, or 4 (red, blue, green, black)
Response	7 seconds (full scale)
Resolution	0.1% steps
Pen lift	Motor-driven, with optional auto-drop

Event Pens

Standard	3-position event recording on any channel
Real time	3-position event recording on the same time line as Pen 1

Chart

Chart size	10 in. or 105 mm
Chart speed	1 to 167 hours or 7 to 32 days per revolution
Rotation accuracy	<0.5% of rotation time

Display and Operator Panels

Displays

Number	2 (1 or 2 pens) or 4 (3 or 4 pens)
Type	6-digit red LED, 0.56 in. (14mm) high
Status indicators	Indicate channel number on display
Alarm indicators	Indicate channels with active alarms

Panel keys

Function	Programming access, increment/decrement, pen lift and user-defined function key
----------	---

Alarms and Logic

Alarms

Number	4 per channel
Type	High/Low process, fast/slow rate of change, time delay
Adjustments	Hysteresis, time delay

Logic Equations

Number	4
Function	OR, AND
Inputs	Alarm states, digital inputs, totalizers, logic
Outputs	Relays, digital outputs, chart stop, alarm acknowledge

Advanced Software Functions

Totalizers

Number	1 per pen
Size	99,999,999 max.
Output	External counter driver, 'wrap' pulse signal

Math

Number of equations	4
Type	+, -, x, ÷, low & high select, max., min., average, mass flow, RH

Timers

Number	2
Type	Real-time clock driven event, adjustable duration
Output	Relay, digital output, logic equation

Option Module*

Number	5 plus 1 x standard input/output module
Connection	Plug-in cards with detachable connection blocks

EMC

Design & Manufacturing standards

CSA General Safety	Approved
UL General Safety	Approved
CSA/FM Class 1 Div. 2	Approved

Emissions and Immunity

Meets requirements of:	
• EN 50081-2	
• EN 50082-2	
• IEC 61326 for an Industrial Environment	
• CE Mark	

Option Module Types

Option module types	I/O per module							Max. no. per instrument
	Analog I/P	Analog O/P	Trans. PSU	Relays	Digital I/P	Digital O/P	Comms.	
Standard I/O	1	1	1	1	2			3
Analog I/P + relay	1			1				5
4 relays				4				2
8 digital I/P					8			3
8 digital O/P						8		3
RS485 communications							1	1
1901J (non-upgradeable)	1							

Ordering Information

PART 1

C1900 recorder		19XX	X	X	X	X	X	X	X	X	X	X	X	X	XXX	OPT
Recorders *	One Pen (Red)	11														
	Two Pens (Red & Green)	12														
	Three Pens (Red, Green, Blue)	13														
	Four Pens (Red, Green, Blue, Black)	14														
Chart Type	Standard (Recorder/Controller)		J													
	KPC 105 PX and PXR type charts		K													
	Chessell Brand charts		C													
Electrical Code	Standard			A												
	CSA approval			B												
	UL approval			U												
	CSA/FM Class 1 Div. 2			F												
Option Module	None				0											
	Additional Modules – Complete PART 2			A												
Options	None					0										
	Totalizer					3										
	Math & Timer					A										
	Totalizer, Math & Timer					B										
Door Lock	Not Fitted									1						
	Fitted									2						
Power Supply	115 V AC															
	230 V AC															
	115 V AC with On/Off Switch															
	230 V AC with On/Off Switch															
PART 2 – Additional Modules				Module Type												
Module Position 2 / Channel 2 Input*				0	1	2										
Module Position 3 / Channel 3 Input*				0	1	2										
Module Position 4 / Channel 4 Input*				0	1	2	3	4	5	6						
Module Position 5				0		2	3	4	5							
Module Position 6				0	2	4	5	8								
Special Settings	Company Standard															STD
	Custom configuration (customer to complete and supply C1900R custom configuration sheet – INF08/032)															CUS
	Special															SXX
	Engineered configuration (customer to supply configuration details required)															ENG
Calibration certificate **																

C1

* Each pen fitted has an associated standard input/output module comprising Analog Input, Analog Output, Relay, Transmitter Power Supply and Two Digital Inputs.
 Additional Input/Output modules may be fitted in the unused module positions as required. These additional modules should be specified in PART 2 of the ordering information.

** When a calibration certificate is ordered it is performed according to the specified configuration type:
 CUS/ENG – Inputs and outputs calibrated according to the customer supplied configuration details and ranges.
 STD – Inputs and outputs calibrated according to the instrument factory standard configuration and ranges.

Accessories

Case-to-panel gasket	C1900/0149
Wall-mount kit	C1900/1712
Pipe-mount kit	C1900/0713
Pack of red pens	C1900/0121
Pack of green pens	C1900/0122
Pack of blue pens	C1900/0120
Pack of black pens	C1900/0119
Pack of purple pens	C1900/0123
After-sales engineered configuration service	ENG/REC

Key to module types

- 0 No module fitted / Pen input channel *
- 1 Standard Input/Output
- 2 Analog input (Math input) + Relay
- 3 Four Relays
- 4 Eight Digital Inputs
- 5 Eight Digital Outputs
- 6 True Time Event Pen (Violet)
- 8 Modbus RS485 Communications

* On 2, 3 or 4 pen instruments a standard I/O module is always fitted in the corresponding module position (enter '0' in the corresponding order code field).

Example. 1 9 1 3 J A A 0 1 1 0 0 3 0 8 STD
 3 pens _____
 4 relays _____
 Modbus RS485 Communications _____

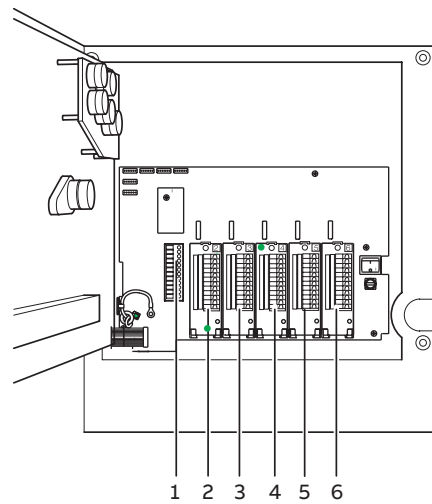

Module Positions

Electrical Connections

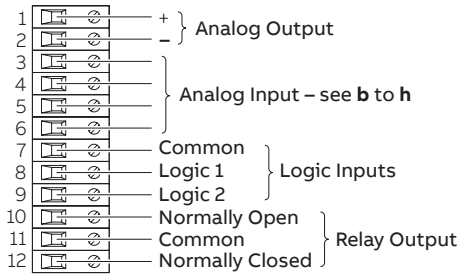

Summary of Connections

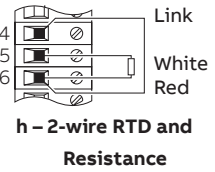
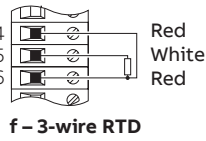
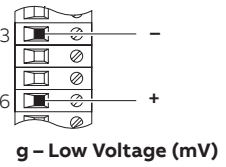
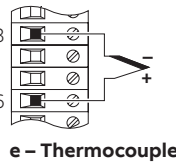
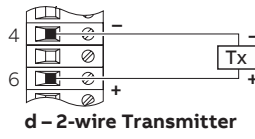
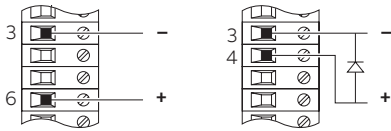

Standard Input/Output Modules

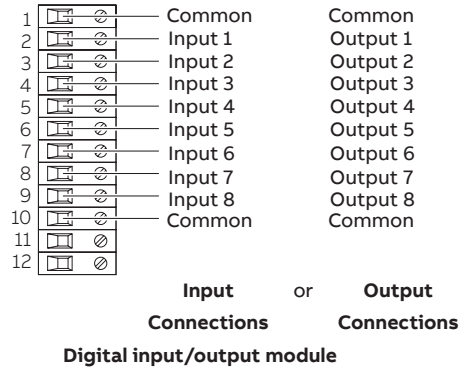
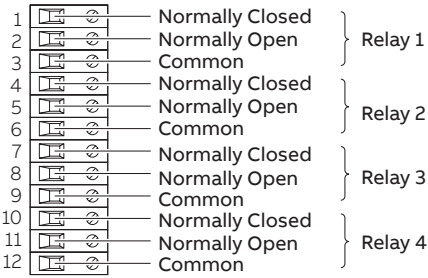

Four-Relay Output Module

Digital input/output module

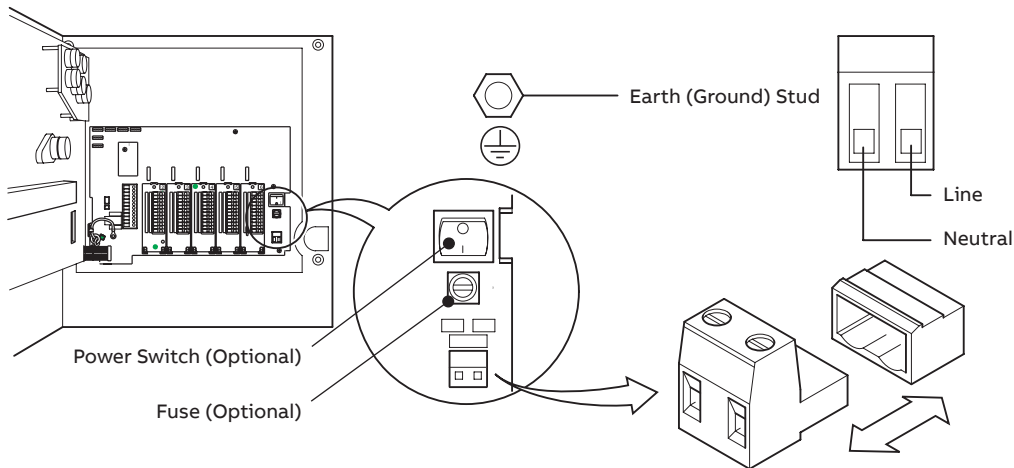

Power Supply Connections

Overall dimensions

Dimensions in mm (in.)

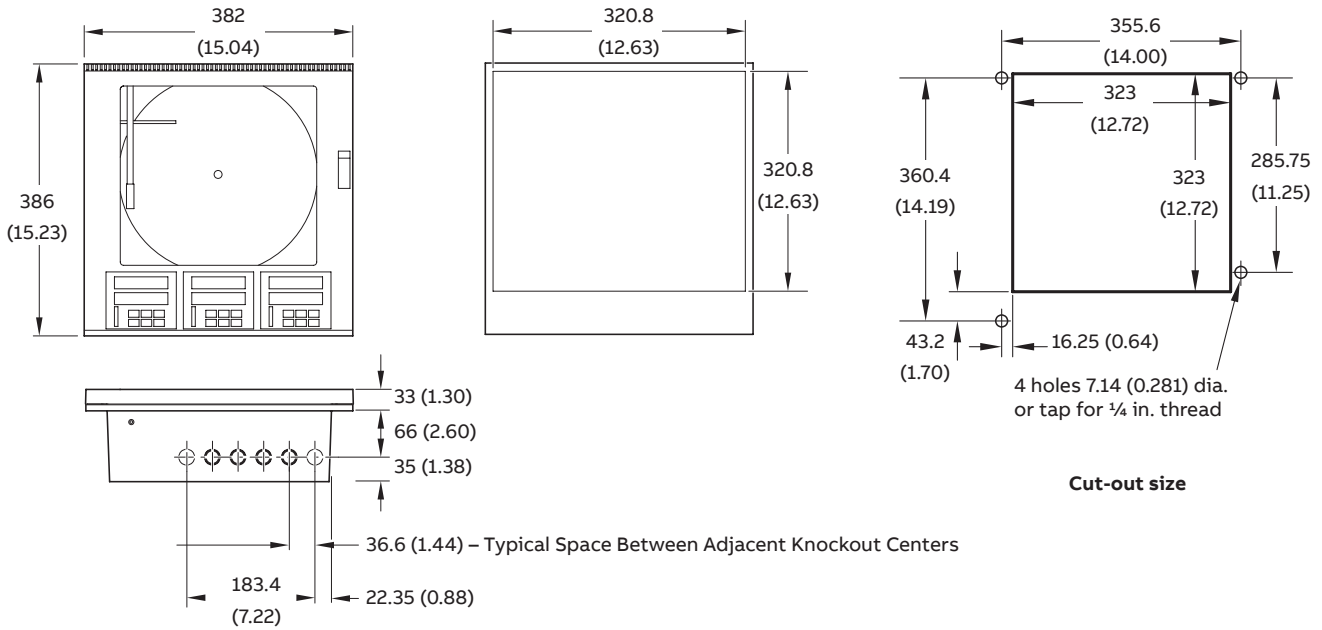

Notes

Sales



Service



Software



ABB Limited**Measurement & Analytics**

Howard Road, St. Neots
Cambridgeshire, PE19 8EU
UK

Tel: +44 (0)1480 475 321

Fax: +44 (0)1480 217 948

Email: instrumentation@gb.abb.com

ABB Inc.**Measurement & Analytics**

125 E. County Line Road
Warminster, PA 18974
USA

Tel: +1 215 674 6000

Fax: +1 215 674 7183

abb.com/measurement

We reserve the right to make technical changes or modify the contents of this document without prior notice. With regard to purchase orders, the agreed particulars shall prevail. ABB does not accept any responsibility whatsoever for potential errors or possible lack of information in this document.

We reserve all rights in this document and in the subject matter and illustrations contained therein. Any reproduction, disclosure to third parties or utilization of its contents – in whole or in parts – is forbidden without prior written consent of ABB.