

Aztec ATS430

Turbidity sensor



Measurement made easy

Introduction

The ATS430 sensor is a rugged, reliable instrument designed to measure the turbidity and suspended solids content of water.

The sensor is designed for use with the ABB AWT440 multi-input transmitter featuring EZLink connection. EZLink enables new or replacement sensors to be easily connected without the need to power down the transmitter.

For more information

Publications for the associated Aztec AWT440 transmitter are available for free download from www.abb.com/measurement (see links and reference numbers below) or by scanning this code:



Sales



Service



search for or click on:

Aztec AWT440 multi-input transmitter Commissioning Instruction	CI/AWT440-EN
Aztec AWT440 multi-input transmitter Data Sheet	DS/AWT440-EN

Contents

1 Health & Safety	3	7 Maintenance	23
1.1 Document symbols	3	7.1 Fitting and replacing the wiper blade	23
1.2 Safety precautions	3	7.2 Diagnostic messages	24
1.3 Potential safety hazards	3	8 Specification	25
1.3.1 Aztec ATS430 sensor – electrical	3	9 Spares and accessories	26
1.3.2 Aztec ATS430 sensor – formazin used to calibrate the sensor	3	9.1 ATS430 spares	26
1.4 Safety standards	3	9.2 ATS 430 accessories	26
1.5 Product symbols	3	9.3 EZLink digital sensor extension cables	26
1.6 Product recycling and disposal (Europe only)	3	9.4 Mounting accessories	26
1.7 Restriction of Hazardous Substances (RoHS)	3	9.5 Replacement parts for ATS430 sensor calibration and verification kit (part no. ATS4000650)	26
2 System overview	4	Appendix A – Principle of operation	27
3 Installation	5	A.1 Turbidity	27
3.1 Siting	5	A.2 Suspended solids	27
3.2 Sensor dimensions	5		
3.3 Mounting / Cleaning options	6		
4 Sensor setup – first-time installation	7		
5 Sensor setup	8		
5.1 Sensor Setup	9		
6 Calibration	10		
6.1 Calibrate menu	10		
6.2 Sensor verification	11		
6.2.1 Preparing the verification tool and locking the sensor in place	11		
6.2.2 Initiating the verification at the transmitter	12		
6.3 Turbidity calibration	13		
6.3.1 Calibration using optional calibration pot ATS400740	13		
6.3.2 1-Point calibration	15		
6.3.3 2-Point calibration	16		
6.4 Suspended solids	17		
6.4.1 Suspended solids calibration	18		
6.4.2 1-Point calibration	18		
6.4.3 2-Point calibration	19		
6.4.4 In process calibration	20		
6.4.5 Sample collection	20		
6.4.6 Collection complete	21		
6.4.7 Manual coefficient	22		
6.5 Calibration log	22		

1 Health & Safety

1.1 Document symbols

Symbols that appear in this document are explained below:

	<p>WARNING – Bodily injury This symbol in conjunction with the signal word 'WARNING' indicates a potentially dangerous situation. Failure to observe this safety information may result in death or severe injury.</p>
	<p>IMPORTANT (NOTE) This symbol indicates operator tips, particularly useful information or important information about the product or its further uses. The signal word 'IMPORTANT (NOTE)' does not indicate a dangerous or harmful situation.</p>

1.2 Safety precautions

Be sure to read, understand and follow the instructions contained within this manual before and during use of the equipment. Failure to do so could result in bodily harm or damage to the equipment.

	<p>WARNING – Bodily injury Installation, operation, maintenance and servicing must be performed:</p> <ul style="list-style-type: none"> — by suitably trained personnel only — in accordance with the information provided in this manual — in accordance with relevant local regulations
--	---

1.3 Potential safety hazards

1.3.1 Aztec ATS430 sensor – electrical

The sensor operates on 24 V DC.

There are no hazardous voltages present in the sensor.

1.3.2 Aztec ATS430 sensor – formazin used to calibrate the sensor

Sensor calibration (see Section 6.3.1, page 13) may require the use of formazin.

	<p>DANGER – Formazin Formazin is a polymerisation of 2 hazardous constituents. Please conduct a full risk assessment based on the supplier's safety datasheet for formazin before use.</p>

1.4 Safety standards

This product has been designed to satisfy the requirements of IEC61010-1:2010 3rd edition 'Safety Requirements for Electrical Equipment for Measurement, Control and Laboratory Use' and complies with US NEC 500, NIST and OSHA.

1.5 Product symbols

Symbols that may appear on this product are shown below:

	Direct current supply only.
	This symbol identifies a risk of chemical harm and indicates that only individuals qualified and trained to work with chemicals should handle chemicals or perform maintenance on chemical delivery systems associated with the equipment.
	This symbol indicates the need for protective eye wear.
	This symbol indicates the need for protective hand wear.
	Recycle separately from general waste under the WEEE directive.

1.6 Product recycling and disposal (Europe only)

	<p>Electrical equipment marked with this symbol may not be disposed of in European public disposal systems after 12 August 2005. To conform to European local and national regulations (EU Directive 2002/96/EC), European electrical equipment users must now return old or end-of-life equipment to the manufacturer for disposal at no charge to the user.</p> <p>ABB is committed to ensuring that the risk of any environmental damage or pollution caused by any of its products is minimized as far as possible.</p>
--	---

	<p>IMPORTANT (NOTE) For return for recycling, please contact the equipment manufacturer or supplier for instructions on how to return end-of-life equipment for proper disposal.</p>
--	---

1.7 Restriction of Hazardous Substances (RoHS)

	<p>The European Union RoHS Directive and subsequent regulations introduced in member states and other countries limits the use of six hazardous substances used in the manufacturing of electrical and electronic equipment. Currently, monitoring and control monitors do not fall within the scope of the RoHS Directive, however ABB has taken the decision to adopt the recommendations in the Directive as the target for all future product design and component purchasing.</p>
--	--

2 System overview

ATS430 sensor components are shown in Fig. 2.1:

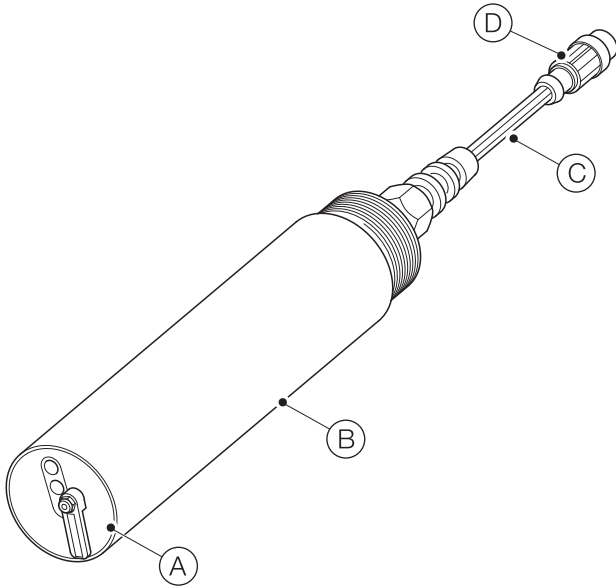

Fig. 2.1 ATS430 sensor components

Item	Feature
(A)	Sensor end cap
(B)	Sensor body (see Table 2.2 for body and end cap material options)
(C)	Sensor cable, 5-way, including M12 connector
(D)	EZLink connector

Table 2.1 Sensor – component descriptions

Sensor no.*	Body material	Wiper	Range
ATS430/A2A1 (1 m [3.2 ft] cable) or ATS430/A2A2 (10 m [32 ft] cable)	Stainless steel 316	Yes (viton)	0 to 4000 NTU
ATS430/A1A1 (1 m [3.2 ft] cable) or ATS430/A1A2 (10 m [32 ft] cable)	Stainless steel 316	No	0 to 4000 NTU
ATS430/A3A1 (1 m [3.2 ft] cable) or ATS430/A3A2 (10 m [32 ft] cable)	Titanium	No	0 to 4000 NTU

*All sensors conform to the ISO 7027 standard.

Table 2.2 Sensor body options / part numbers

3 Installation

3.1 Siting

i IMPORTANT (NOTE)

- The sensor is supplied with a protective cover on the end cap. The cover must be removed before the sensor can be operational.
- When installing the sensor, ensure that the front face of the sensor is submerged to at least 30 cm (11.81 in.) and the sensor is at least 5 cm (1.96 in.) away from any surface in all directions.
- When using extension cables, protect the connections using heat shrink (for example, HISA-18/6-PEX-CL or equivalent).

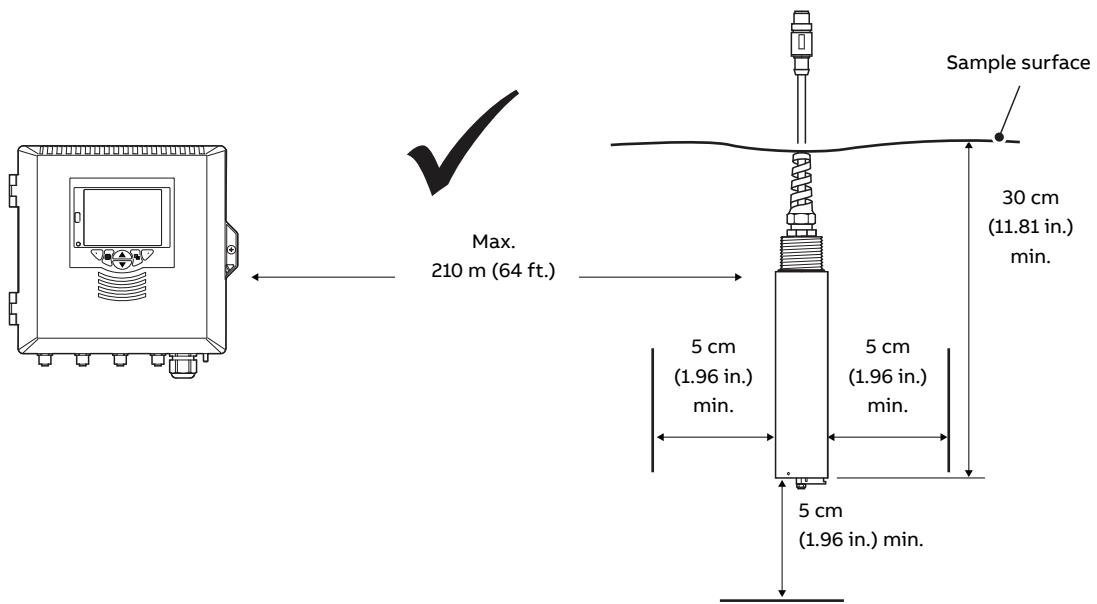

Fig. 3.1 Siting the sensor

3.2 Sensor dimensions

Dimensions in mm (in.).

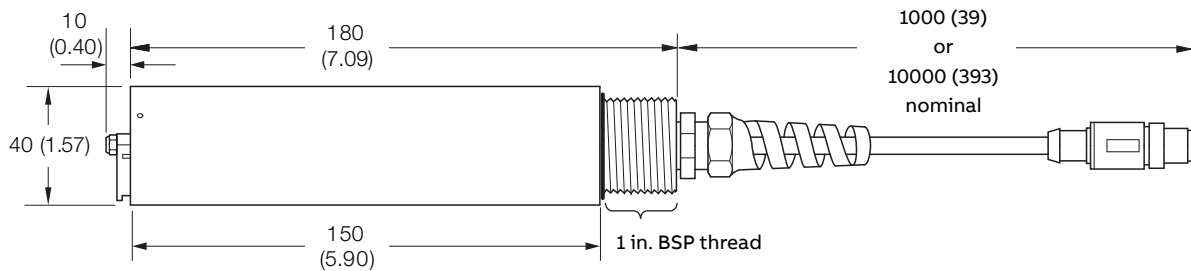

Fig. 3.2 Sensor dimensions

3.3 Mounting / Cleaning options

Sensor mounting / cleaning options are shown in Table. 3.1 / Fig. 3.3:

Item	Mounting option
(A)	Open channel mounting kit: — ATS4000768, suitable for floor/wall (surface) mounting (ATS4000720 chain mounting kit available separately)
(B)	Wall mounting accessory: — ATS4000700, suitable for 40 mm / 1.25 in dia dip pole
(C)	Dip pole assembly (supplied with 40 mm dia pole): — ATS4000750: 2.5 m (8.2 ft) straight — ATS4000716: 2.5 m (8.2 ft) 90° bend — ATS4000719: 2.5 m (8.2 ft) 45° bend Dip pole mounting adaptor kits (to attach to user-supplied pole) — ATS4000751: for attachment to 40 mm dia or 1.25 in NB pole (straight) — ATS4000710: for attachment to 1.25 in NB pole (90° bend) — ATS4000711: for attachment to 1.25 in NB pole (45° bend) — ATS4000714: for attachment to 40 mm dia. pole (90° bend) — ATS4000715: for attachment to 40 mm dia. pole (45° bend) Note. Handrail mounting brackets are not supplied with this kit and must be purchased separately.
(D)	Open tank flanged dip mount: — ATS4000785, for mounting on user-supplied mounting bracket
(E)	Wiper arm protective shroud assembly: — ATS4000725
(F)	Flow cell pipeline mount: — ATS4000741, suitable for wall / surface mounting (includes wall mounting clip)
(G)	Handrail mounting bracket – swivel / tilt action: — ATS4000762 for 1.25 in NB dip pole, suitable for 42 or 51 mm (1.7 or 2.0 in) dia. handrail — ATS4000763 for 40 mm dia dip pole, suitable for 42 or 51mm (1.7 or 2.0 in) dia. handrail
(H)	Handrail mounting bracket – tilt action: — ATS4000760 for 40mm or 1.25 in dia dip pole, suitable for 42 or 51mm (1.7 or 2.0 in) dia handrail
(I)	Retractable insertion assembly: — ATS4000780, maximum pressure 10 bar (145 psi), for mounting on user-supplied flange: BS EN 1092-1, Type 01B, DN50, PN16, stainless steel 316L or similar. Maximum distance from flange sealing face to pipe I/D must not exceed 70 mm (2.75 in.).

Table 3.1 ATS430 sensor mounting / cleaning options

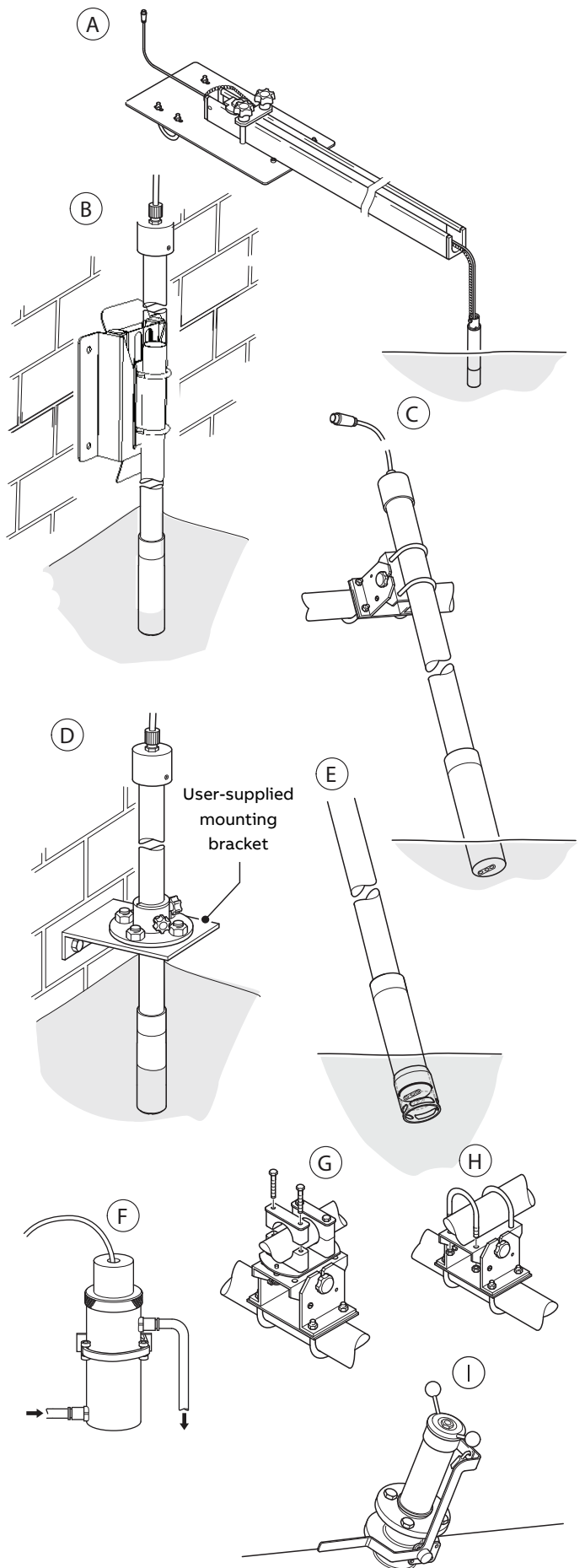

Fig. 3.3 ATS430 sensor mounting / cleaning options

4 Sensor setup – first-time installation

i IMPORTANT (NOTE)



Perform this procedure when a new / replacement sensor is connected to the transmitter for the first time only. For existing sensors, see Section 5, page 8.

To perform a first-time installation (**Easy Setup** menu):

1. Connect a new or replacement sensor to the transmitter's EZLink connector – see transmitter Operating instructions [OI/AWT440-EN](#).

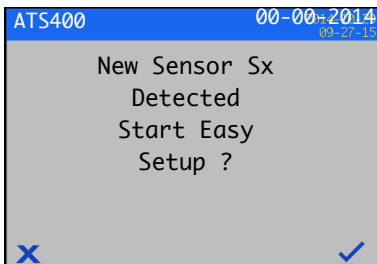
The following prompt is displayed identifying the new / replacement sensor (S1 to S4):



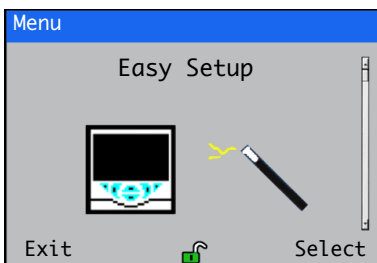

2. To enter **Easy Setup** level, press the  key (below the  icon).

The **Easy Setup** start screen is displayed:



Press the  key (below the **Select** prompt).

3. To enter **Easy Setup** level, press the  key (below the **Select** icon).
4. Press the  key (below the **Edit** prompt) to change the default value to the required value / selection.
5. Press the  key (below the **Next** prompt) to accept the value / selection displayed and advance to the next configuration parameter.

The following Configuration parameters are set at **Easy Setup** level:

- Tag
- PV Type
- Units
- Range High
- Range Low
- Clean Interval
- Filter Type
- Analogue outputs and alarms

i IMPORTANT (NOTE)

Refer to Section 5.1, page 9, for parameter details – not all parameters in Section 5.1 are displayed at **Easy Setup** level.

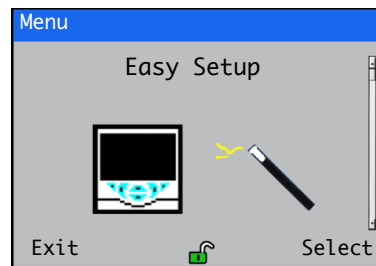

6. Continue with configuration of the required parameters.

On completion the **Easy Setup** start screen is displayed:



7. To exit **Easy Setup**, press the  key (below the **Exit** prompt) to display the **Operator Page**.

Pressing the  key (below the **Select** prompt) re-enters the **Easy Setup** level where parameters can be reviewed or modified after 1st time connection.

After completing the **Easy Setup** level, pressing the  or  key enters the **Advanced Configuration** level, where all available sensor and transmitter parameters can be reviewed or modified.

i IMPORTANT (NOTE)



To re-configure an existing sensor (after first-time installation), enter the **Configuration** level (see Section 5.1, page 9) via the **Operator Page** – refer to transmitter Operating instructions [OI/AWT440-EN](#) for **Operator Page** details and navigation.



5 Sensor setup

i IMPORTANT (NOTE)

Perform this procedure on existing sensor(s) only. Sensors are setup / configured individually. If installing a new / replacement sensor, refer to Section 4, page 7.

1. Connect the ATS430 sensor to the transmitter's EZLink connector – see transmitter Operating instruction [OI/AWT440-EN](#).
2. At the AWT440 transmitter, press the  key to display the **Operator Page** menu, then select **Enter Configuration** to display the **Access Level** page.

Use the  key to select the **Advanced** menu item and press the  key (below the **Select** prompt).

If the **Sensor Setup** menu is not displayed use the  /  keys to scroll to it:

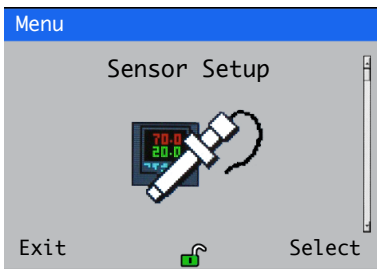

Press the  key (below the **Select** prompt).

3. The **Sensor Setup** page is displayed:

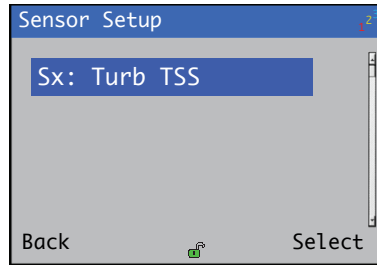

Ensure **Sx :Turb TSS** is highlighted and press the  key (below the **Select** prompt).

The **Sx :Turb TSS: Turbidity** menu page is displayed:

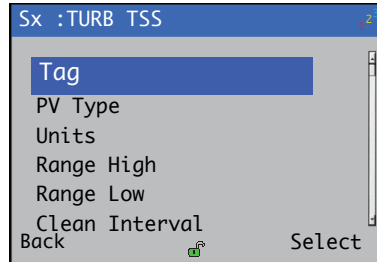

4. Proceed with sensor setup – see Section 6.1, page 10 for parameter options.

5.1 Sensor Setup

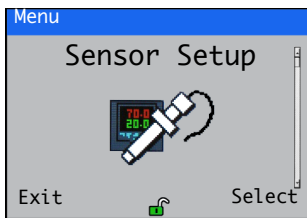

Used to set the sensor tag, operational range, filtering parameters and clean interval.

Menu	Comment	Default
S1 (to 4) : TURBIDITY	Select the turbidity sensor to set up.	
Tag	Enter an alphanumeric sensor tag (16 characters maximum) to identify the sensor on the Operator Pages .	TAG1
PV Type	Select measurement type. Note. If a change is made the I/O sources are reset. Turbidity / Suspended Solids	Turbidity
Turb Units	Select the turbidity units: NTU / FNU	NTU
SS Units	Select the units for suspended solids: mg/l / ppm For readings above 1000 mg/l (ppm) the units change to g/l (ppt).	mg/l
Range High	Set the span value in Chart and Bargraph views.	4000 NTU (turbidity) 1000 mg/l (suspended solids)
Range Low	Set the zero value in Chart and Bargraph views.	0 NTU (turbidity) 0 mg/l (suspended solids)
Filter Type	Select the signal filtering type: Off / Low / Medium / High / Bubble Reject	Off
Clean Interval	Set the interval between cleans: Off / 15 mins / 30 mins / 45 mins / 1 to 24 Hours	Off
Clean Mechanism	None (for non wiper versions), Wiper (for wiper versions) or External . The external option allows the transmitter to control an external cleaning device through the digital I/O lines. Note. Refer to the Aztec ADS430 EZCLEAN operating instructions (OI/ADS430/EZCLN-EN) for an example of the use of this facility.	
Clean Type*	Set the clean type: Continuous / Pulsed .	Continuous
Clean On Time*	Set the duration of the clean: 1 to 60 s	30 secs
Clean Off Time* / **	Set the duration between cleans: 1 to 60 s	30 secs
Recovery Time*	Set the time delay between the completion of cleaning and the display of a new reading on the operator page: 1 to 10 min	1 min
Clean Duration*	Displays the total duration of the clean: Clean Type set to Continuous = Clean on Time + Recovery Time Clean Type set to Pulsed = (Clean on Time + Clean Off Time) x Number of Pulses + Recovery Time	
Clean Output*	Displays the output signal the clean is assigned to. This can be set to relay 1 to 6 or digital output 1 to 6.	No Assignment
Reset Wiper Lifetime	Available only for sensors with wipers. Use to restart the wiper lifetime counter after wiper replacement.	
Restore Defaults	Returns all settings back to default values.	N/A

*Displayed only if Clean Interval is **NOT** set to **Off** AND Clean Mechanism is set to **External**.

Displayed only if Clean Type is set to **Pulsed.

6 Calibration

This section describes how to calibrate the sensor and involves measuring the sensor's sensitivity to turbidity and / or suspended solids by exposing the sensor to samples of known turbidity or suspended solids content.

Calibrations are initiated via the **Cal** prompt displayed on the main page or via the **Operator** pages or **Calibrate** and **Advanced** menu items on the **Access Level** page – refer to transmitter Operating instructions [OI/AWT440-EN](#) for all transmitter menu options.



IMPORTANT (NOTE)

- Do not perform a calibration until the sensor and transmitter are installed and ready for operation.
- Before removing the sensor for calibration purposes, set the currents outputs and alarms to **Hold** (enabled via the **Operator Menu / Manual Hold** function).

6.1 Calibrate menu

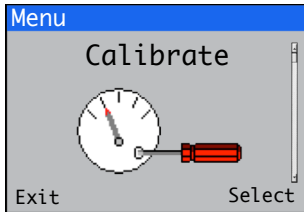

Used to calibrate the sensor.

Access to the **Calibrate** menu is via the **Calibrate** and **Advanced** levels only.

Note. During calibration, current outputs and alarms are set to **Hold** automatically if **Hold Outputs** is enabled (see below).

- Refer to Section 6.2, page 11 to perform a sensor verification.
- Refer to Section 6.3, page 13 to perform a turbidity calibration.
- Refer to Section 6.4, page 17 to perform a suspended solids calibration.

Menu	Comment	Default
S1(to 4) : TURB TSS	Select the turbidity sensor to calibrate.	
Sensor Verification		
Turbidity Calibration		
1-Point Cal	General purpose span calibration.	
2-Point Cal	Calibration for better accuracy.	
Suspended Solids Cal		
1-Point Cal	General purpose span calibration.	
2-Point Cal	Calibration for better accuracy.	
Sample Collection	Sample collection in progress.	
Collection Complete	Sample collection completed.	
Manual Coefficient	Enter the coefficient that relates the turbidity of the sample to its suspended solids content.	
Restore Defaults	Restores default values to their factory settings.	
Hold Outputs	Enable / disable the Hold Outputs function. If enabled, the current outputs and alarm functions are held during calibrations.	Enabled

6.2 Sensor verification

6.2.1 Preparing the verification tool and locking the sensor in place

The verification tool can be used to verify sensor operation as an alternative to using formazin. Using the verification tool eliminates the need to handle potentially hazardous chemicals (formazin) during routine verification.

i IMPORTANT (NOTE)

- Ensure the verification tool carrier is kept clean and any dirt is removed after each use.
- Ensure the sensor is clean of dirt and fouling prior to insertion into the verification tool (step 7).
- Take care not to damage the surface of verification pucks. When using the puck in locations where grit or sand may be present, ensure the sensor is thoroughly clean before inserting it into the verification tool. Any debris on the front face of the sensor will prevent the puck making full contact with the sensing area and result in a reading error as well as possible damage to the puck.

Referring to Fig. 6.1:

1. Select a verification puck with the NTU value suitable for the application – the NTU value is printed on puck label (A).
2. Remove protective cap (B) from puck (C).
3. Align slot (D) (opposite puck label (A)) with sprung ball screw (E) located within the bore of the lower section of verification tool (F).
4. Press puck (C) into place taking care not to touch the upper surface and confirm a puck of the correct NTU value has been fitted – the NTU value of the puck is visible through front aperture (G).
5. Pour a few drops of coupling agent (H) onto the puck surface, near the centre of the circle.
6. Ensure slider (I) is in the unlocked position.
7. Insert sensor (J) into verification tool (F) and align the (2 opposing) holes (K) with notch (L) on the verification tool top cap.

i IMPORTANT (NOTE)

Sensors with accessories connected:

- sensor (J) is shown with a standard cable attached. If accessories (such as dip pole, chain adaptor) are connected there is no need to disconnect them. Verification can be performed with accessories in place. For flow cell mounted sensors, unscrew the flow cell adaptor from the sensor then slide it up the cable.

Aligning sensors fitted with wiper:

- orientate the sensor with the wiper blade to the front (open cut-out) to ensure correct alignment with the puck. This also ensures correct alignment with the locking plate peg. To avoid damage to the wiper arm, wiping is disabled automatically while the sensor is inserted in the verification tool.

i **IMPORTANT (NOTE)** When pushing the sensor into the verification tool body (step 8), ensure the sensor is inserted straight so that the sensor face is placed directly onto the puck surface.

8. Push sensor (J) down until the holes (K) in the sensor body are within the top cap, then push slider (I) to the locked position to lock sensor (J) in place.
9. Refer to Operating instruction [OI/AWT440-EN](#) and initiate a verification routine.
10. When the verification routine is complete, carefully wipe puck (C) and verification tool (F) clean, refit puck cap (B) and store all items into the case supplied with the kit.

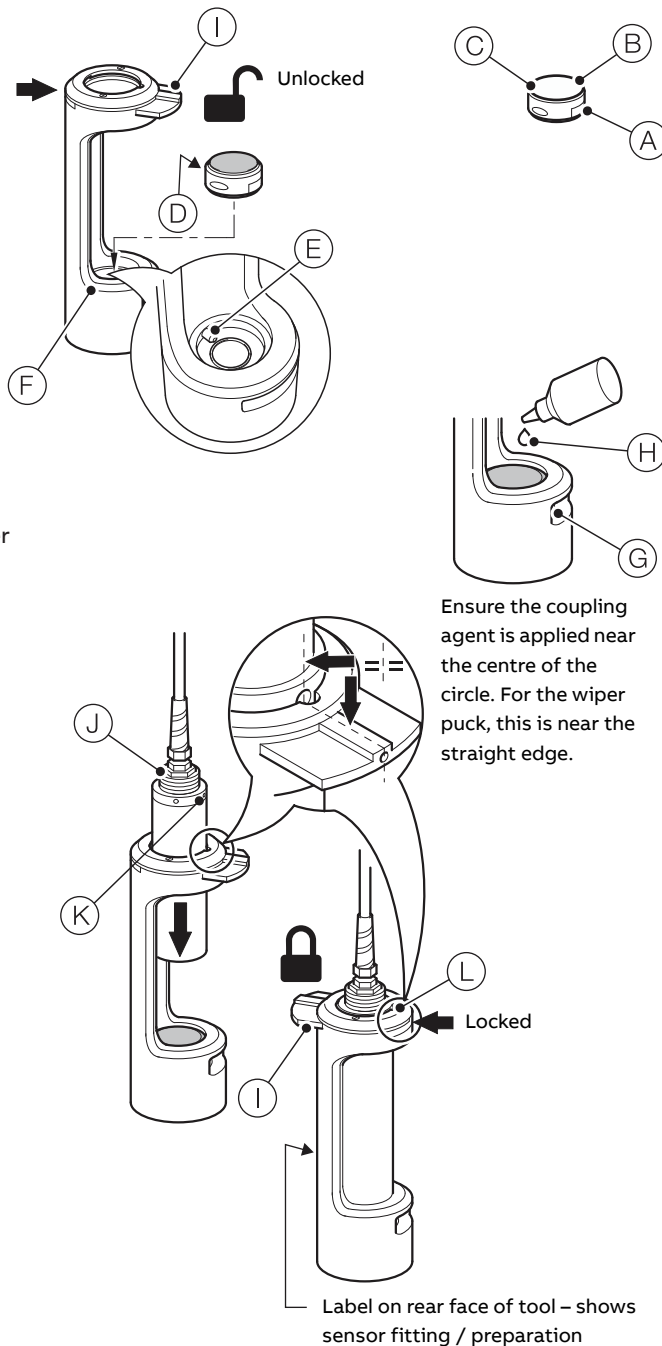

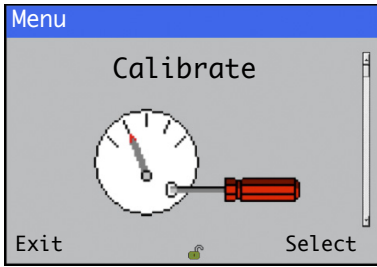

Fig. 6.1 Using the verification tool

6.2.2 Initiating the verification at the transmitter

- At the Calibrate level, press the  key (below the Select prompt):





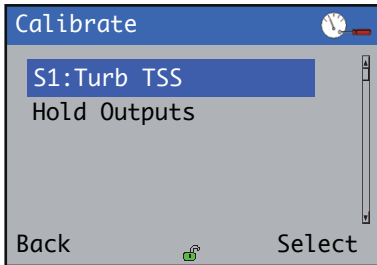

The sensor selector menu is displayed:

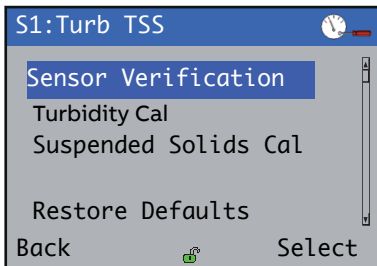

Highlight the sensor to be verified (for example **S1:Turb TSS**) and press the  key (below the Select prompt).

- The menu options for **S1:Turb TSS** are displayed:



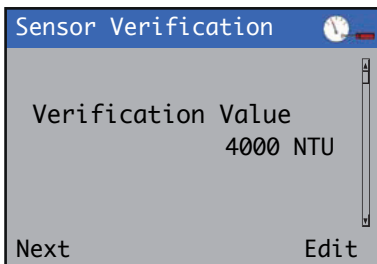

- Use the  /  keys to select **Sensor Verification** and press the  key (below the Select prompt).

The **Sensor Verification** screen is displayed:



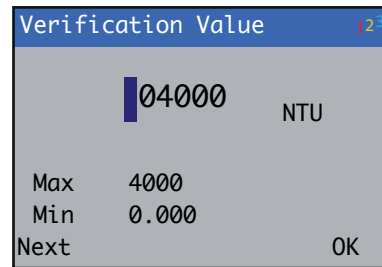

- Press the  key (below the Edit prompt) to enter the value of the verification puck.

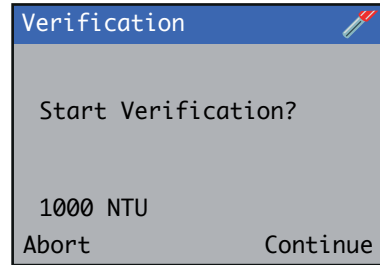

- Enter the turbidity value printed on the puck label and press the  key (below the OK prompt).

The Start Verification screen is displayed:



Ensure the sensor is inserted in the verification tool (see Section 6.2.1, page 11) and press the  key (below the Continue prompt) to start the verification routine. (To **Abort** verification, press the  key).

- The **Verification** progress screen is displayed:

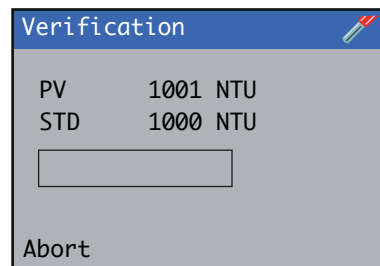

If the verification process completes successfully, a verification successful message (**Procedure Pass**) is displayed:

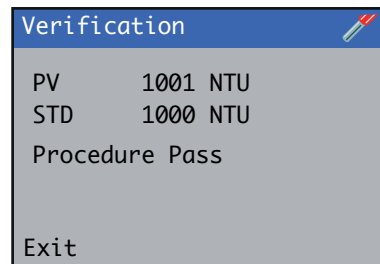

7. If the verification fails, a verification failure message (**Procedure Failed**) is displayed:

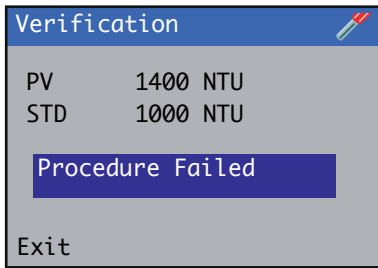

This may indicate that the sensor requires calibration.

6.3 Turbidity calibration

Used to calibrate the sensor to measure turbidity. There are two possible calibration modes:

- 1-Point calibration, refer to Section 6.3.2, page 15
- 2-Point calibration, refer to Section 6.3.3, page 16

A 1-point calibration adjusts the Calibration Slope and is suitable for general operation.

A 2-point calibration is recommended when measuring low turbidity values (below 50 NTU). The Offset and Slope are adjusted resulting in improved accuracy at low turbidity concentrations.

When performing calibrations for measuring low turbidity values (below 50 NTU), ensure the sensor reading is not affected by light scattered by the calibration solution container. Use a large container (minimum 1 litre) and ensure that the sensor is immersed by no more than 5 cm below the solution surface and is at least 5 cm from the container walls.

For low level applications that use the ABB Flowcell (ATS4000741), use the Calibration Pot (part no. ATS4000740) to calibrate the sensor. See Section 6.3.1.



DANGER – Formazin

Formazin is a polymerisation of 2 hazardous constituents. Please conduct a full risk assessment based on the supplier's safety datasheet for formazin before use.



When calibrating using high NTU values of formazin, stir the solution continuously throughout the procedure. If the calibration is performed outside, shield the calibration vessel from direct sunlight.

Before starting the calibration process, ensure that the vessel and the sensor are cleaned and dried thoroughly to avoid contaminating calibration solutions. Before adding formazin to the vessel, ensure the solution is mixed thoroughly by rocking (not shaking) the bottle gently.

6.3.1 Calibration using optional calibration pot ATS400740

The calibration pot (part no. ATS4000740) is recommended for use in the following situations:

- **When performing a calibration in direct sunlight.**
The calibration pot excludes ambient light that can affect the measurement.
- **For low level applications (less than 50 NTU) that use the ABB flowcell (ATS4000741)**
The interior properties (dimensions and surface finish) of the flowcell and calibration pot are comparable, resulting in a matched calibration.
- **For high concentration calibrations, when the use of large quantities of formazine solution is not desirable.**
The calibration pot requires only 200 ml of calibration solution.

Do not use the calibration pot in low level applications (less than 50 NTU) that either do not use the flowcell or where the sensor is mounted more than 5 cm away from any surface, as the surface light scattering in the calibration pot could result in an offset in the reading.



IMPORTANT (NOTE)

- When inserting the sensor into the calibration solution take care not to trap air bubbles in the front face of the sensor. For sensors with wiper, perform a wipe before proceeding with calibration.
- Sensors with accessories connected:
 - sensor (B) (Fig. 6.2, page 14:) is shown with a standard cable attached. If accessories (such as dip pole, chain adaptor) are connected the calibration can still be performed with them in place.

Referring to Fig. 6.2, page 14:

1. Slide cap (A) onto sensor (B) until the cap is close to the top of the sensor.
2. Hold cap (A) and press sensor (B) down using an anti-clockwise twisting motion until sensor (B) connects.



IMPORTANT (NOTE)

Cap (A) has 2 sprung-loaded ball screws (C) that engage with 2 holes (D) in the top ring of sensor (B). Confirm correct alignment by checking that 2 grooves (E) on the top face of cap (A) align with holes (D) / ball screws (C) when cap is connected.

For sensors installed in a flow cell, the flow cell thread adaptor can be used instead of the calibration pot cap. Alternatively, unscrew the adaptor and slide back to allow the cap to fit onto the sensor.

3. Carefully pour 200 ml (6.76 ounce [US, liquid]) of formazin (F) into calibration pot (G).
4. Carefully slide sensor / cap assembly (H) into calibration pot (G) until fully inserted.

5. Perform a sensor calibration at the transmitter:
 - see Section 6.3.2, page 15 for a 1-point calibration
 - see Section 6.3.3, page 16 for a 2-point calibration.
6. When the calibration is complete, withdraw sensor / cap assembly (H) from calibration pot (G). Remove cap (A) from sensor (B) (a combined pull and twist action is the easiest withdrawal method). Rinse all items with water and dry thoroughly with tissue (not supplied).
7. Dispose of formazin solution safely in accordance with local regulations.

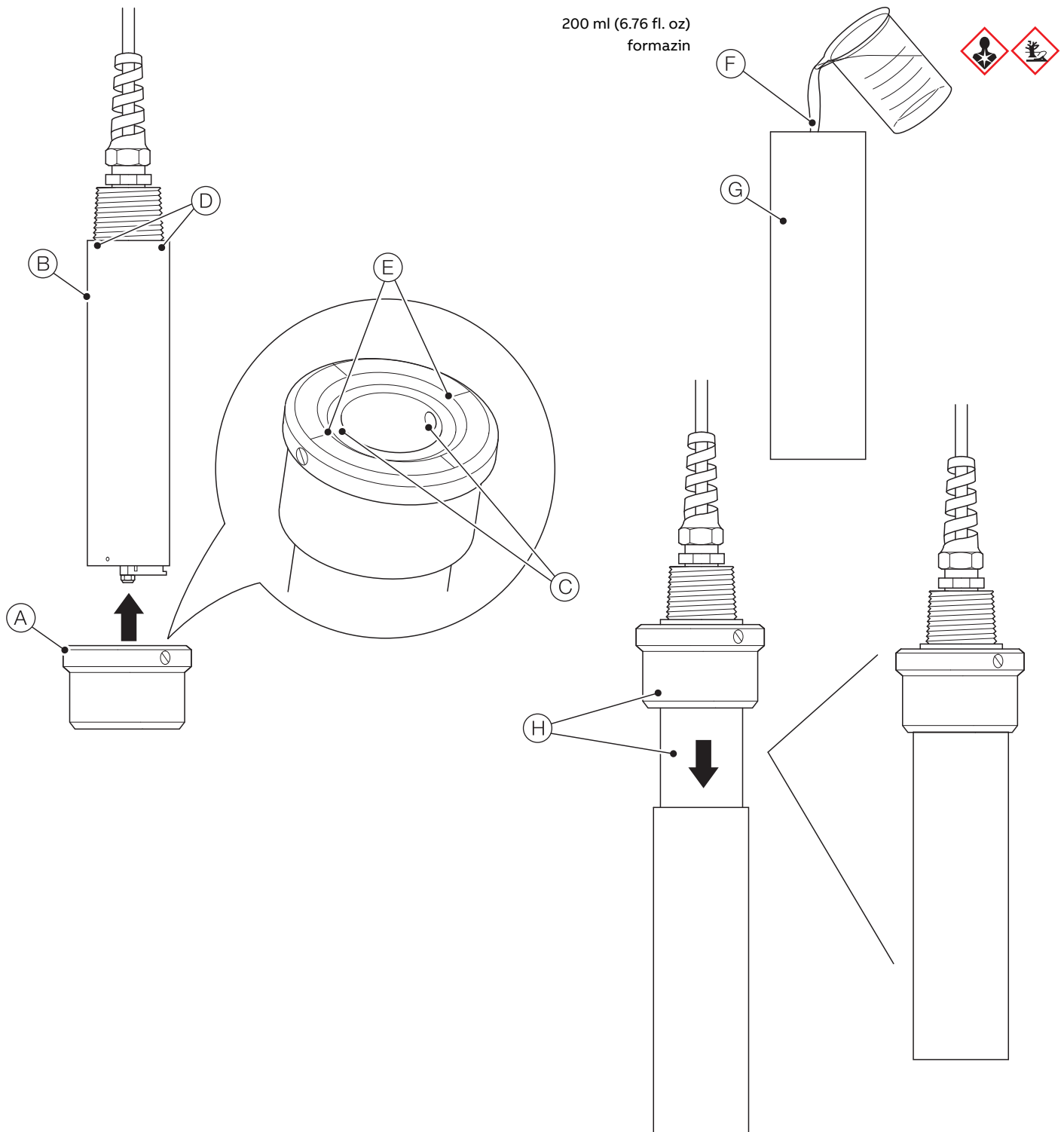

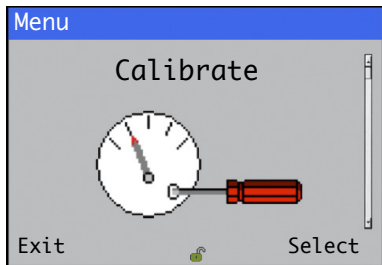

Fig. 6.2 Calibration using the optional calibration pot

6.3.2 1-Point calibration

For the 1-point calibration only a span value is used. The span value can be provided by a verification puck, a formazin solution or an AMCO standard.

1. At the Calibrate level, press the  key (below the Select prompt):





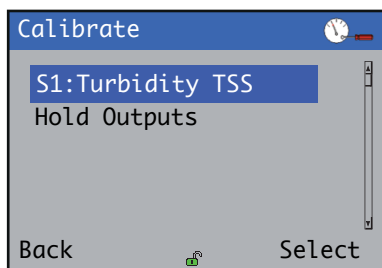

The sensor selector menu is displayed:

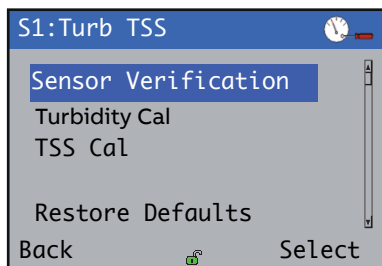

Highlight the sensor to be calibrated (for example S1:Turbidity TSS) and press the  key (below the Select prompt).

2. The menu options for S1:Turbidity TSS are displayed:



3. Use the  /  keys to select Turbidity Cal and press the  key (below the Select prompt).

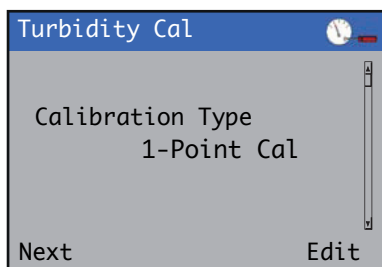

The Turbidity Cal screen is displayed:

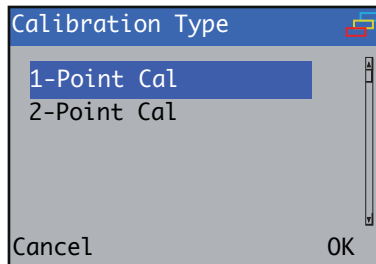

4. Press the  key (below the Edit prompt).

The Calibration Type screen is displayed:



5. Use the  /  keys to select 1-Point Cal and press the  key (below the OK prompt).

Press the  key (below the Next prompt).

The Turbidity / Offset screen is displayed:

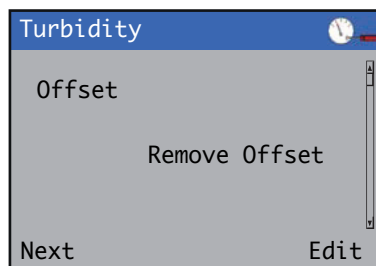



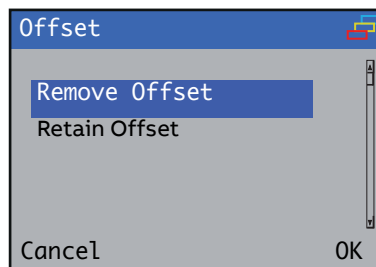

For most cases a zero offset is suitable. However, in situations where an offset was previously determined during a 2-point calibration, it is possible to retain the previously measured offset during the 1-point calibration.

6. To select the required offset press the  key (below the Edit prompt).

The Offset / Remove Offset | Retain Offset screen is displayed:



7. Use the  /  keys to select Retain Offset and press the  key (below the OK prompt) to confirm the selection and use the existing offset, or select Remove Offset to remove the offset (an offset of 0 NTU is assumed).

The Turbidity | Calibration Value screen is displayed where the calibration value can be modified by pressing the  key (below the Edit prompt).

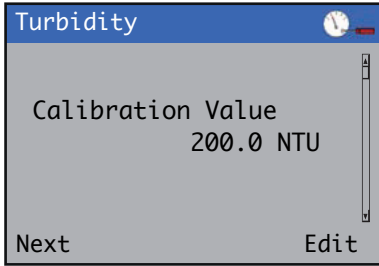

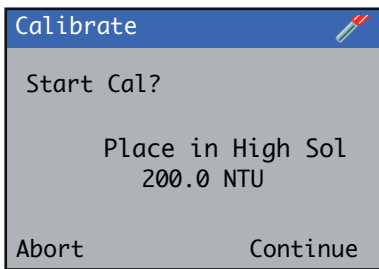

When the required value is set, press the  key (below the Next prompt).

8. Once the value shown on screen matches the span value, insert the sensor in the verification tool or solution and press the  key (below the Continue prompt).

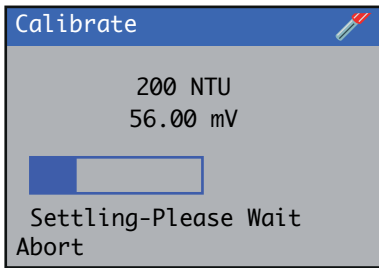

The calibration process screen is displayed – the calibration can be cancelled at any time during the process by pressing the  key (below the Abort prompt):



9. If the calibration is successful the final screen displays the new slope. Press the  key (below the Exit prompt) to return to the main menu.

The 1-point calibration is now complete.

6.3.3 2-Point calibration

2 Solutions are used for a 2-point calibration. This calibration is used when more accuracy is needed over a given range, using calibration solutions at either end of the desired range.

1. At the Calibrate level, press the  key (below the Select prompt):

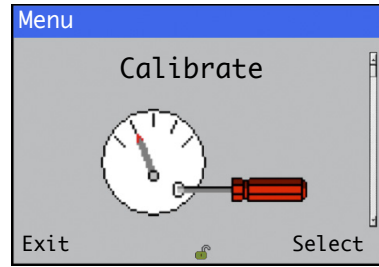



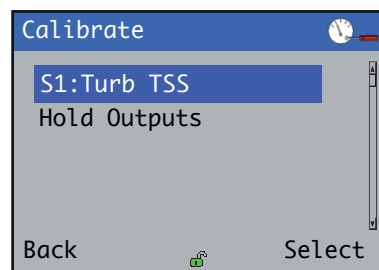

The sensor selector menu is displayed:

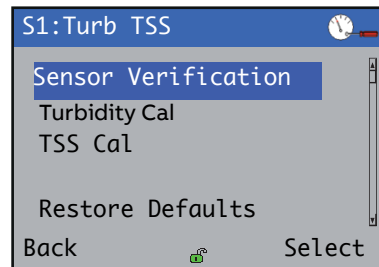

2. Highlight the sensor to be calibrated and press the  key (below the Select prompt).

The menu options for S1: Turb TSS are displayed:



3. Use the  /  keys to select Turbidity Cal and press the  key (below the Select prompt).

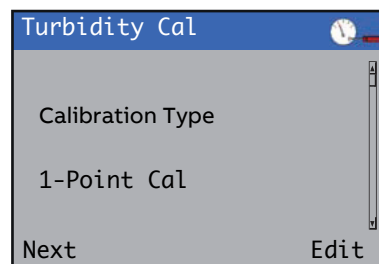

The Turbidity screen is displayed:



- Press the  key (below the Edit prompt).

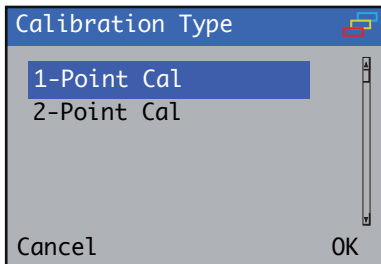

The Calibration Type screen is displayed:



- Use the  /  keys to select 2-Point Cal and press the  key (below the OK prompt) to start the 2-point calibration. The Turbidity / Low Solution Value screen is displayed where the first point value can be entered:

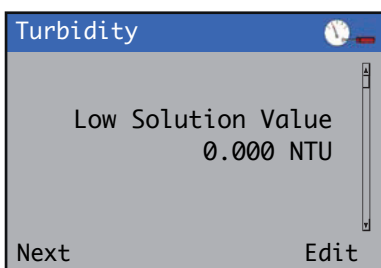

Press the  key (below the Next prompt).



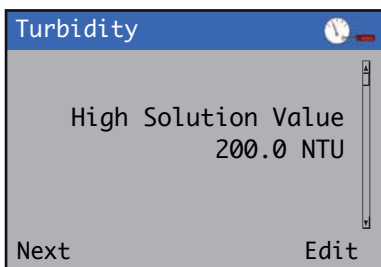

Press the  key (below the Edit prompt) to enter the value of the lower calibration point. Press the  key (below the OK prompt). Press the  key (below the Next prompt) to set the value and display the Second Point Value screen.

- On the Turbidity / High Solution Value screen press the  key (below the Edit prompt) to enter the value of the higher calibration point.

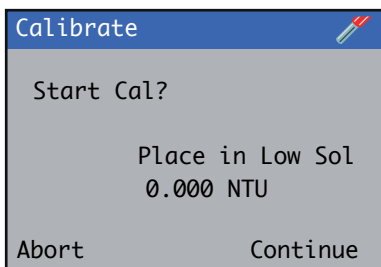

- Place the sensor in the lower calibration solution, press the  key (below the OK prompt), press the  key (below the Next and press the  key (below the Continue prompt).



The calibration process screen is displayed – the calibration can be cancelled at any time during the process by pressing the  key (below the Abort prompt):

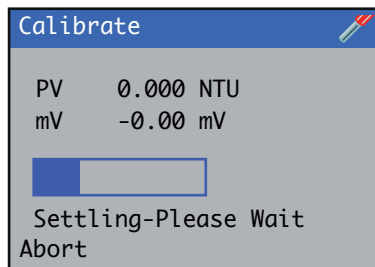

- When acquisition is complete remove the sensor from the first calibration point, clean and insert the sensor into the second calibration point. Clean and dry the sensor thoroughly, to avoid cross contamination of the calibration solutions. Press the  key (below the Continue prompt) to start data acquisition.

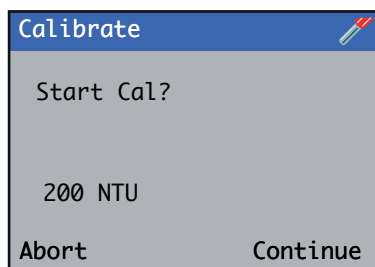

If the calibration fails a message is displayed indicating the reason for failure. If the calibration is successful the final screen displays the new slope. Press the  key (below the Exit prompt) to return to the main menu.

The 2-point calibration is now complete.

6.4 Suspended solids

There are 4 possible calibration modes for suspended solids:

- **1-Point calibration:** assumes that there is no zero offset, so a single point is used to calculate the linear relation between turbidity and suspended solids – refer to Section 6.4.2, page 18
- **2-Point calibration:** two solutions of known suspended solids concentrations are used to determine the linear relation between turbidity and suspended solids – refer to Section 6.4.3, page 19
- **In-Process calibration:** used in situations where it is not possible to remove the sensor from the process. A grab sample is taken from the process for laboratory determination of the suspended solids content, and the sensor stores the turbidity value being read at the time the sample was taken – refer to Sections 6.4.4, page 20 to 6.4.6, page 21
- **Manual coefficient:** allows the user to input a coefficient obtained from data analyzed in the lab – refer to Section 6.4.7, page 22.

6.4.1 Suspended solids calibration

To perform a suspended solids calibration:

1. At the Calibrate level, press the  key (below the Select prompt):

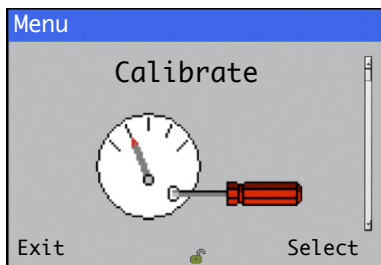

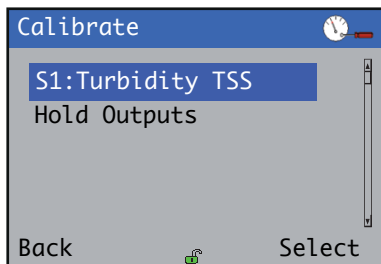

The sensor selector menu is displayed:



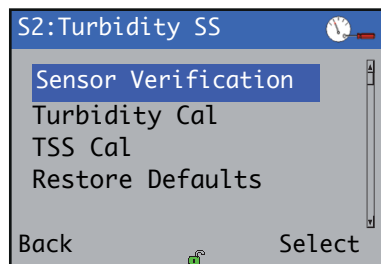



2. Highlight the sensor to be calibrated and press the  key (below the Select prompt). The menu options for calibration are displayed:



3. Use the  /  keys to select TSS Cal and press the  key (below the Select prompt) to enter the calibration menus.

6.4.2 1-Point calibration

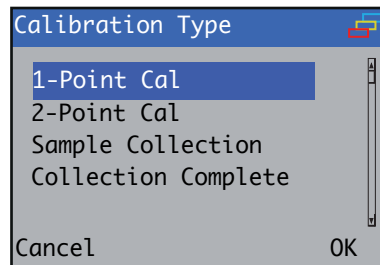

A solution of a known turbidity and suspended solids content is used to calibrate the sample.

1. At the Calibration Type screen, press the  key (below the Edit prompt), use the  /  keys to select 1-Point Cal and press the  key (below the OK prompt):



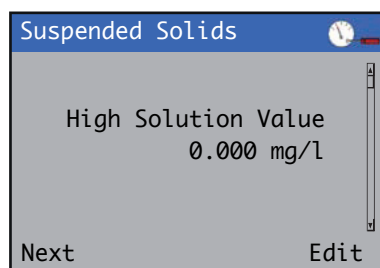

The Suspended Solids / High Solution Value screen is displayed. Press Next:



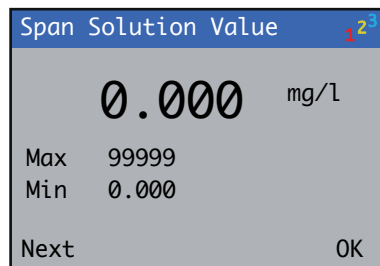

2. Press the  key (below the Next prompt) to start the calibration.
3. In the following screen, press the  key (below the Edit prompt) to enter the suspended solids content of the calibration sample.

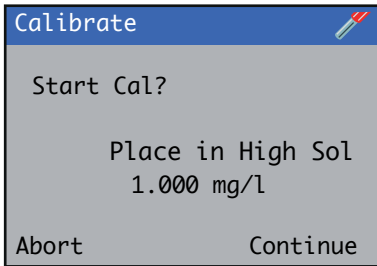

4. Press the  key (below the OK prompt) once the value has been entered.

- Place the sensor in the sample when prompted and press the  key (below the Continue prompt) to start the calibration:





The calibration progress window is displayed. When acquisition is complete a screen displays the calibration coefficient. Press the  key (below the Exit prompt) to return to the main menu.



The calibration is now complete.

6.4.3 2-Point calibration

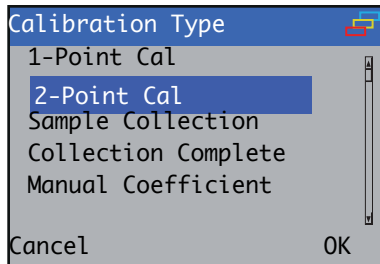

Two solutions are used for a 2-point calibration. This calibration is used when more accuracy is needed over a given range, using calibration solutions at either end of the required range.

- At the Calibration Type screen, use the  /  keys to select 2-Point Cal and press the  key (below the OK prompt):

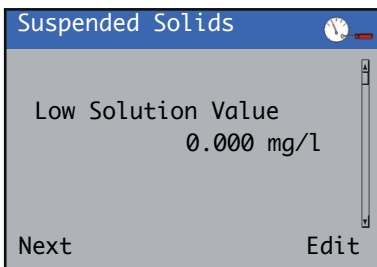

- On the next screen, press the  key (below the Next prompt).
- On the Low Solution Value screen press the  key (below the Edit prompt) to enter the value of the lower calibration point. Press the  key (below the Next prompt) once the value is entered.



- On the 2nd Point Value screen press the  key (below the Edit prompt) to enter the value of the higher calibration point. Press the  key (below the Next prompt) once the value is entered.

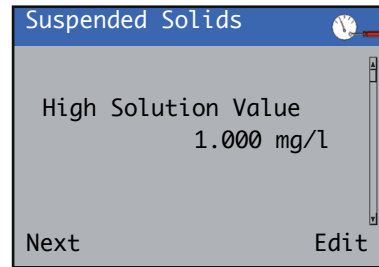

- Place the sensor in the lower calibration point and press the  key (below the Continue prompt).

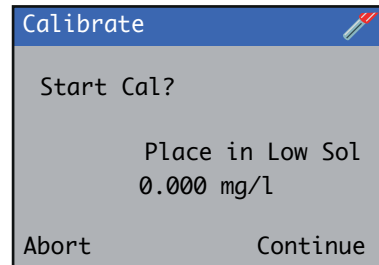

The calibration process screen is displayed – the calibration can be cancelled at any time during the process by pressing the  key (below the Abort prompt):

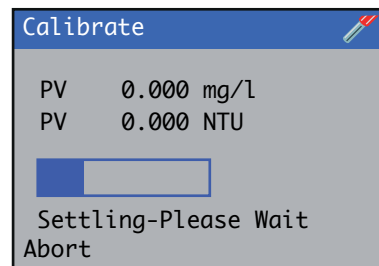

- On completion, remove the sensor from the first calibration point, clean and insert the sensor into the second calibration point. Press the  key (below the Continue prompt) to start data acquisition.

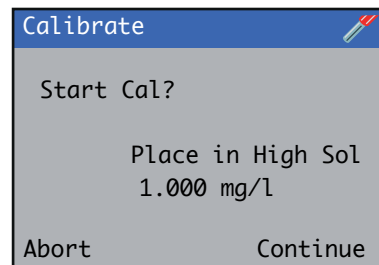

- If the calibration fails a message is displayed indicating the reason for failure. If the calibration is successful the next screen displays the new slope. Press the  key (below the Exit prompt) to return to the main menu.

The 2-point calibration is now complete.

6.4.4 In process calibration

In process calibration is used when it is not possible to remove the sensor from the process to perform the calibration. In this calibration mode the actual sample is used to calibrate the sensor.

The in process calibration takes place in two steps. During the first step a grab sample is taken from the process, and the sensor records the turbidity of the sample at that time. The suspended solids content of the grab sample is then measured in the laboratory and entered into the transmitter during the second step.

Due to the inherent variability of both the turbidity and suspended solids measurements, using a single point to calibrate the suspended solids measurement can lead to sudden jumps in the suspended solids value reported by the sensor. (The ATS430 sensor supports an adaptive calibration mode, which mitigates the occurrence of such jumps.) – refer to AN/ANAINST/021-EN for details of adaptive calibration.

1. At the Calibration Type screen, use the \uparrow / \downarrow keys to select **Sample Collection** and press the \checkmark key (below the **OK** prompt):

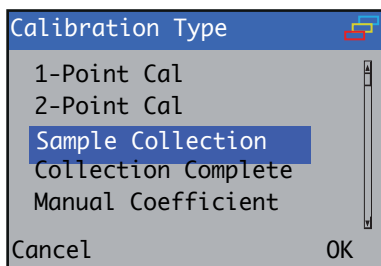

2. Proceed to Section 6.4.5 (Sample collection) to start the first part of the calibration.

6.4.5 Sample collection

1. This is the first step of the calibration. On the next screen, press the \checkmark key (below the **Next** prompt).

Performing this step erases any sample collection performed previously. Only the last sample collection performed is stored in the sensor.

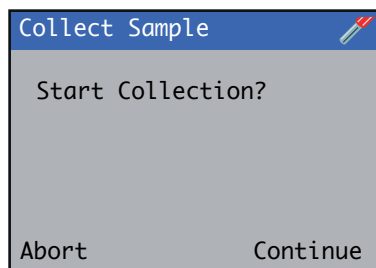

2. On the following screen press the \checkmark key (below the **Continue** prompt) to start the data collection. The grab sample should be taken as close to the sensor as possible during this period.

The calibration process screen is displayed – the acquisition can be cancelled at any time during the process by pressing the \checkmark key (below the **Abort** prompt):

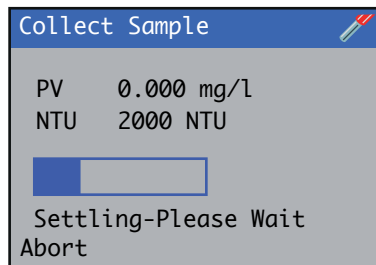

3. Once the acquisition is complete, Press the \checkmark key (below the **Exit** prompt) to return to the main menu.

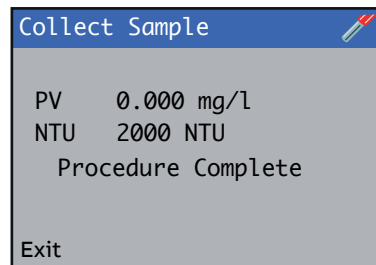

The value of the sample turbidity is now stored.

4. Proceed to Section 6.4.6 (Sample collection) to start the second part of the calibration once the suspended solids value has been determined.

6.4.6 Collection complete

This is the second step of the calibration. Once the suspended solids content of the sample has been measured in the laboratory, the value can be entered into the transmitter. Note that this sample must correspond to the last sample collection step performed, otherwise the calibration may not be correct.

1. To start the **Collection Complete** procedure from the **Calibration Type** screen, use the \uparrow / \downarrow keys to select **Collection Complete** and press the \checkmark key (below the **Edit** prompt).

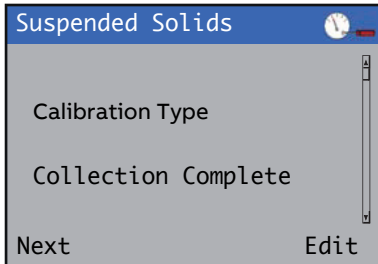

The **Suspended Solids / New Process** screen is displayed:

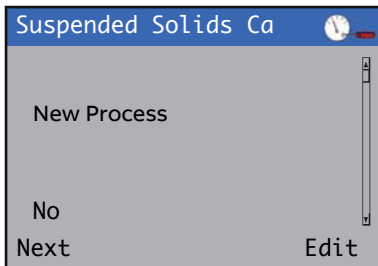

2. Press the \checkmark key (below the **Edit** prompt).

The **New Process** screen is displayed:

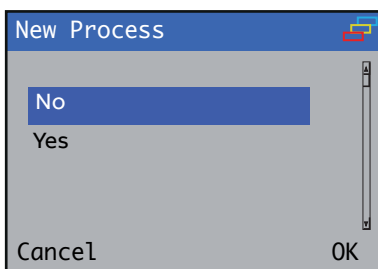

3. To start collection for a new process (when the sensor is installed for the first time in a new process or when the calibration needs to be reset) use the \uparrow / \downarrow keys to select **Yes**.

To retain the memory of the previous calibrations (adaptive calibration to fine tune the existing suspended solids calibration) select **No**.

4. Press the \checkmark key (below the **OK** prompt).
5. Press \downarrow key (below the **Next** prompt).

The **Collection Complete** screen is displayed:

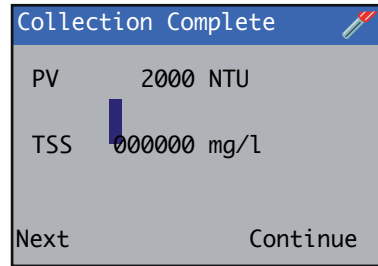

This screen displays the turbidity recorded when the sample was taken (read-only **PV** field) and a field (**TSS**) to enter the suspended solids value measured in the lab.

6. Use the \uparrow / \downarrow keys to enter the suspended solids value (ensure the value entered is in the same units as those displayed in the screen) and press the \checkmark key (below the **Continue** prompt) when complete.

A new calibration coefficient based on the value entered, and the previous values if using adaptive calibration, is calculated.

The calibration is now complete.

7. Press the \downarrow key (below the **Exit** prompt) to return to the main menu.

6.4.7 Manual coefficient

This calibration mode enables the user to enter directly the coefficient that relates the turbidity of the sample to its suspended solids content. The sensor uses the following equation to calculate suspended solids content from turbidity (see Fig. A.2, page 27):

$$SS = T/a$$



Where:

- SS is the suspended solids content in the required units (mg/l or ppm),
- T is the turbidity in NTU
- a is the coefficient.

If a set of data points of turbidity and suspended solids, the coefficient can be calculated by plotting the suspended solids (y-axis) against turbidity (x-axis) and fitting a straight line with an intercept of 0. The calibration coefficient is the slope from the linear fit of the data.

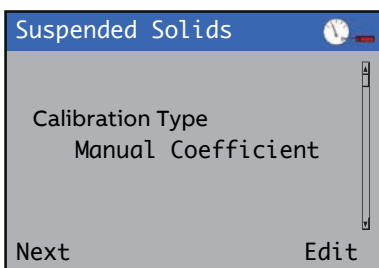
1. To enter a coefficient, select **Manual Coefficient** from the **Calibration Type** screen and press the  key (below the **Next** prompt).



2. Press the  key (below the **Edit** prompt) to enter the value of the coefficient and press the  key (below the **OK** prompt) when complete.

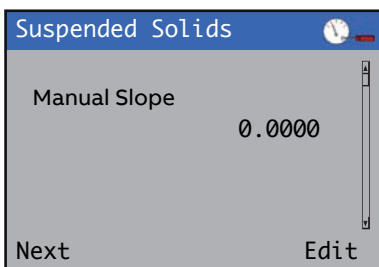

3. The **Calibration Complete** screen is displayed. Press the  key (below the **Next** prompt) to return to the main menu.

The calibration is now complete.

6.5 Calibration log





The calibration log stored in the sensor holds a record of the last 15 calibration operations undertaken on the sensor. To view the calibration log in the transmitter, logs must be enabled first. Refer to the AWT440 transmitter manual ([OI/AWT440-EN](#)) for details of how to enable logs.

Once logs are enabled, a calibration log page exists for each of the sensors connected to the transmitter. To access the calibration log, press the **View** key on the transmitter keypad (the first calibration log is displayed):

No.	Event	Date	Time
01	Slope Low	2016-02-12	09:42:32
02	1.01 / 0 NTU	2016-02-12	09:40:33
03	Cal Aborted	2016-02-12	09:39:16
04	Verification	2016-02-12	09:37:59
05	Verification	2016-02-12	09:36:13

Fig. 6.3 Calibration log for Sensor 1, showing the result of different calibration and verification operations

Use the group key in the keypad to cycle through the calibration logs for each of the sensors. The log shows the result of the last 15 calibration operations undertaken. The result can be:

- **Calibration aborted** : if calibration is stopped (by the user) part of the way through
- **Calibration failed** : the log entry displays the reason for the calibration failure
- **Verification successful** : if the sensor passes verification
- **Verification failed** : if the sensor failed verification
- **Calibration successful** : the log entry displays the new calibration parameters

Each entry displays the date and time the operation was performed. Note that the date and time are taken from the transmitter. To ensure the date and time stored in the log are accurate, ensure the date and time set in the transmitter are correct.

7 Maintenance

7.1 Fitting and replacing the wiper blade

Referring to Fig. 7.1:

1. Refer to the AWT440 transmitter operating instruction ([OI/AWT440-EN](#)) and stop wiper operation.
2. Remove sensor from sample and clean the sensor.
3. Using a 5.5 mm spanner or hex nut driver, remove nyloc retaining nut (A).
4. Remove wiper arm (B) complete with blade and captive O-ring.
5. Thoroughly clean wiper motor shaft (C) and sensor end face and check condition. If the shaft is damaged, consult the factory.
6. Lightly grease captive O-ring within the new wiper arm assembly.
7. Align the flat in the new wiper arm assembly with the flat on wiper motor shaft (C) and fit the arm to the shaft, ensuring the wiper blade faces the sensor end cap.
8. Insert supplied feeler gauge (D) between the wiper arm captive O-ring and the sensor end cap.
9. Fit a new nyloc M3 nut and tighten until feeler gauge (D) is lightly pinched but can be removed without excessive force. Remove the feeler gauge.
10. Refer to the AWT440 transmitter Operating instruction ([OI/AWT440-EN](#)) and re-start the wiper operation. Ensure the wiper arm functions correctly by issuing a manual clean request from the transmitter.
11. Replace the sensor in the sample.
12. Refer to Section 5.1, page 9 to reset the wiper lifetime.

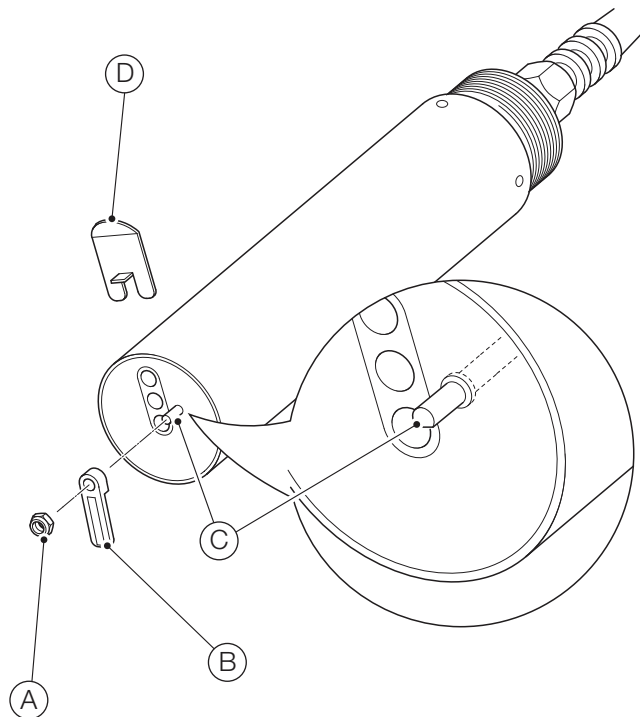





Fig. 7.1 Fitting and replacing the wiper















7.2 Diagnostic messages

The table below shows sensor-specific icon types, diagnostic messages and possible causes / suggested remedial action.

i IMPORTANT (NOTE)

- The diagnostic icons in the following tables conform to NAMUR 107.
- For transmitter-specific diagnostics messages, refer to AWT440-EN.

Diagnostic Icon	NAMUR Status
	Error / Failure
	Out of specification
	Maintenance required
	Check function

Icon	Message	Possible cause / suggested action
	PV failure	The LED is not illuminating the sample. Cycle power to sensor.
	ADC Failure	An error has been reported by the on board ADC. Cycle power to sensor.
	NV Failure	Failure of non-volatile memory on sensor board. Cycle power to sensor. If power cycling fails, reset the sensor configuration to default and reconfigure as needed.
	Cal. Failed	The last calibration failed. Repeat calibration procedure.
	Out of Range	The measured turbidity is outside the specified range.
	Wiper Expired	The wiper blade is overdue for replacement. Replace the wiper blade and issue wiper blade replaced command.
	Temperature Out of Range	The internal sensor temperature is outside operating limits. Verify that the sample temperature is within the operating range of the sensor (0 to 60 °C [32 to 140 °F])
	Excess Light	Excess ambient light is present stopping sensor from operating. Shade the sensor, or move to an area where the sunlight is excluded.
	Wiper Failed	The wiper has failed to wipe. Check wiper for blockage.
	Replace Wiper	The wiper blade is due for replacement. Replace wiper blade and issue wiper blade replaced command.
	LED Expired	The LED is going to fail shortly.
	Cal In Progress	A calibration is in progress.
	In Recovery	The sensor is in recovery mode after performing a calibration.
	Clean Progress	The wiper is currently cleaning.
	Clean Inhibited	Wiping is inhibited.

8 Specification

Sensor type

Optical nephelometric turbidity and suspended solids sensor

Sensor

IP rating

IP68

Range

Turbidity: 0 to 4000 NTU

Suspended solids: dependent on sample:

- up to 5000 mg/l kaolin
- up to 15000 mg/l Fullers earth
- up to 100,000 mg/l SiO₂

Accuracy^{1,2}

Turbidity: <±2 % measured value

Suspended solids: dependent on sample

Repeatability & Limit of Detection

Repeatability¹: <1 %

Limit of detection³: 0.006 NTU

Display resolution

Turbidity: 0.001 NTU

Suspended solids: 0.001 mg/l

Response time

T90 < 30 s with filtering disabled

Storage conditions

–5 to 70 °C (23 to 158 °F)

Operating temperature

0 to 60 °C (32 to 140 °F)

Operating pressure

Up to 10 bar (145 psi) for metal versions

Dimensions

40 mm (1.57 in.) diameter

180 mm (7.08 in.) length

Weight

Stainless steel: approx. 0.65 kg (1.43 lb) without cable

Titanium: approx. 0.4 kg (0.88 lb) without cable

Power

Consumption (maximum)

100 mA @ 24 V DC

Cable

Fixed length

1 or 10 m (3.28 or 32.8 ft.)

EZLink digital sensor connector IP rating

IP67 (when connected)

Extension cable (options)

1, 5, 10, 15, 25, 50 m (3.2, 16.4, 32, 49.2, 82, 164 ft.)

Maximum length (including optional extension cable)

Up to 210 m (826 ft.)

Methods

ISO7027:1999, Water Quality – Determination of turbidity

Materials of construction

Stainless steel version

316L Stainless Steel, Viton, Noryl (wiper version only),
Sapphire and F08 Epoxy

Titanium version

Titanium grade 2, Sapphire and F08 Epoxy

Sensor flow cell body

ABS

Retractable insertion assembly

Parts in contact with sample:

Stainless steel (316/1.4408), Viton, TFM™1600

¹ Tested in accordance with MCERTS: Performance Standards and Test Procedures for Continuous Water Monitoring Equipment. Version 3.1: Environment Agency 2010.

² ±0.1 NTU for measurement below 5 NTU, provided an accurate calibration is performed to compensate for environmental interferences. To achieve the best accuracy at low levels a two-point calibration is advised.

³ Tested in accordance with BS ISO 15839: 2003.

9 Spares and accessories

9.1 ATS430 spares

Part number	Description
ATS4000788	Replacement O-ring (pack of 2)
ATS4000799	Wiper replacement kit (pack of 6)

Table 9.1 ATS430 spares

9.2 ATS 430 accessories

Part number	Description
ATS4000650	ATS430 Sensor calibration and verification kit
ATS4000725	Wiper arm protection shroud
ATS4000740	Calibration pot
ATS4000717	Hook wrench, Ø40 mm

Table 9.2 Accessories

9.3 EZLink digital sensor extension cables

Part number	Description
AWT4009010	1 m (3.2 ft.) extension cable
AWT4009050	5 m (16.4 ft.) extension cable
AWT4009100	10 m (32 ft.) extension cable
AWT4009150	15 m (49.2 ft.) extension cable
AWT4009250	25 m (82 ft.) extension cable
AWT4009500	50 m (164 ft.) extension cable

Table 9.3 EZLink digital sensor extension cable

9.4 Mounting accessories

Part number	Description
ATS4000741	Flow cell
ATS4000785	Open tank flanged dip mount
ATS4000768	Open channel mounting kit supplied with 3 mm (9.8 ft.) chain
ATS4000720	Chain fitting adaptor kit supplied with 3 mm (9.8 ft.) chain
ATS4000700	Wall mounting bracket for dip pole (40 mm or 1.25 in NB)
ATS4000760	Handrail mounting bracket (Tilt) for dip pole (40 mm or 1.25 in NB) suitable for 42 or 51 mm (1.7 or 2.0 in.) dia. handrail
ATS4000762	Handrail mounting bracket (Swivel & Tilt) for dip pole (1.25 in NB) suitable for 42 or 51 mm (1.7 or 2.0 in.) dia. handrail
ATS4000763	Handrail mounting bracket (Swivel & Tilt) for dip pole (40 mm) suitable for 42 or 51 mm (1.7 or 2.0 in.) dia. handrail
ATS4000751	Pole mounting adaptor kit (straight) for attachment to 40 mm or 1.25 in NB pole
ATS4000710	Pole mounting adaptor kit (90°) for attachment to 1.25 in NB pole
ATS4000711	Pole mounting adaptor kit (45°) for attachment to 1.25 in NB pole
ATS4000714	Pole mounting adaptor kit (90°) for attachment to 40 mm pole
ATS4000715	Pole mounting adaptor kit (45°) for attachment to 40 mm pole
ATS4000750	Dip / pole assembly (straight), metric 2.5 m (8.2 ft)
ATS4000716	Dip / pole assembly (90° bend), metric 2.5 m (8.2 ft)
ATS4000719	Dip / pole assembly (45° bend), metric 2.5 m (8.2 ft)
ATS4000780	Retractable insertion assembly
ADS430168	Flow cell spares kit – contains replacement push-fit connectors, o-ring, gasket and base plug
ATS4000796	Retractable insertion assembly spares kit – contains replacement o-rings, washers and circlip

Table 9.4 Mounting accessories

9.5 Replacement parts for ATS430 sensor calibration and verification kit (part no. ATS4000650)

Part number	Description
ATS4000692	Replacement puck, low, non wiper (typically 900 NTU)
ATS4000693	Replacement puck, high, non wiper (typically 2500 NTU)
ATS4000697	Replacement puck, low (wiper) (typically 900 NTU)
ATS4000698	Replacement puck, high (wiper) (typically 2500 NTU)
ATS4000643	ATS430 sensor calibration coupling agent (15 ml)

Table 9.5 Replacement parts for ATS430 sensor calibration and verification kit (part no. ATS4000650)

Appendix A – Principle of operation

A.1 Turbidity

Turbidity provides a measurement of water clarity. When there is material in water that scatters light, its presence manifests itself as turbidity, this material may be (for example) algae, silt, air bubbles.

The ABB turbidity sensor determines turbidity by measuring the amount of light scattered by the sample at 90° from the direction of illumination, see Fig. A.1. This arrangement is commonly referred to as Nephelometric detection.

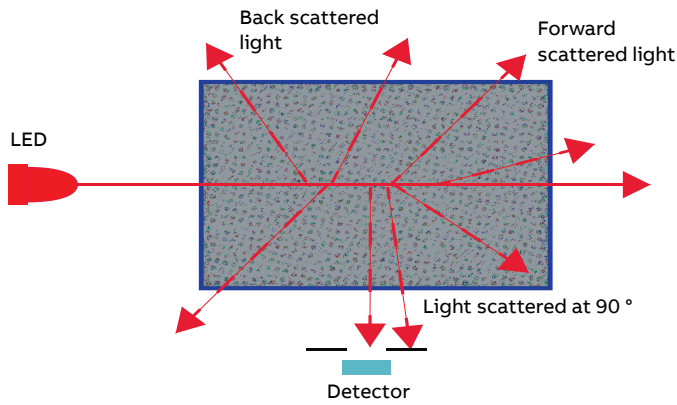

Fig. A.1 Light scattering from a turbid sample

The optical design of the instrument follows the guidelines set out in the ISO7027 Standard*. The light source is an LED emitting at a wavelength of 850 nm. Light scattered at 90° is collected by a photodiode.

*Reference: Water Quality – Determination of turbidity: ISO, 1999. ISO 7027:1999(E).

A.2 Suspended solids

Suspended solids content in water is usually measured using ASTM method D5907-10**, that involves filtering the sample through filter paper and measuring the increase in weight of the filter paper. This method can provide quite accurate results, but is rather time consuming, requires trained personnel and precision laboratory equipment, and cannot provide results in real time.

It is possible to use the long known relation between the amount of solids in suspension and the turbidity of a sample to estimate, in real time, the suspended solids content of the sample.

For a given sample, it is possible to build a calibration curve to convert the turbidity value to a suspended solids value, as shown in Fig. A2:

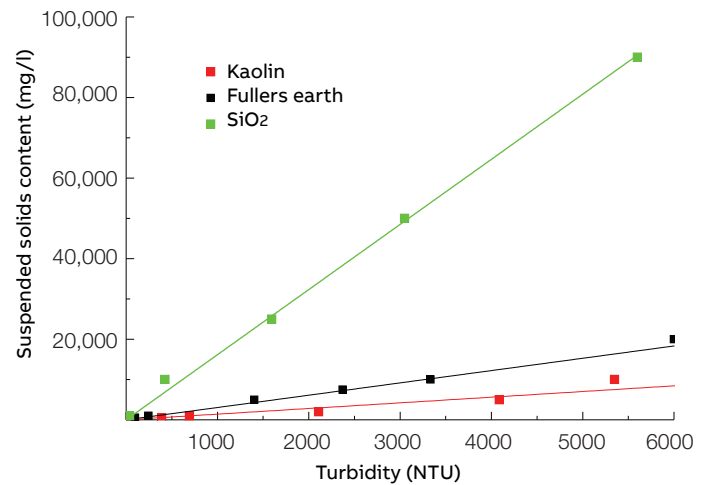

Fig. A.2 Relationship between suspended solids and turbidity for Fullers earth and kaolin

As can be seen in Fig. A2, the relationship between turbidity and suspended solids is specific to a particular sample, as is the range of suspended solids values that can be measured.

**Reference: Standard test methods for filterable matter (Total Dissolved Solids) and nonfilterable matter (Total Suspended Solids) in water: ASTM, 2010. ASTM D5907-10.

For a detailed explanation of the measurement of turbidity and suspended solids, refer to white paper [WP/ANAINST/002-EN](#)

ABB Limited

Measurement & Analytics

Oldends Lane, Stonehouse

Gloucestershire,

GL10 3TA

UK

Tel: +44 (0)1453 826661

Fax: +44 (0)1453 829671

Mail: instrumentation@gb.abb.com

ABB Inc.

Measurement & Analytics

125 E. County Line Road

Warminster, PA 18974

USA

Tel: +1 215 674 6000

Fax: +1 215 674 7183

abb.com/analytical



We reserve the right to make technical changes or modify the contents of this document without prior notice. With regard to purchase orders, the agreed particulars shall prevail. ABB does not accept any responsibility whatsoever for potential errors or possible lack of information in this document.

We reserve all rights in this document and in the subject matter and illustrations contained therein. Any reproduction, disclosure to third parties or utilization of its contents – in whole or in parts – is forbidden without prior written consent of ABB.