

PERFORMANCE
MADE
SMARTER

Product Manual

6337

2-wire HART transmitter

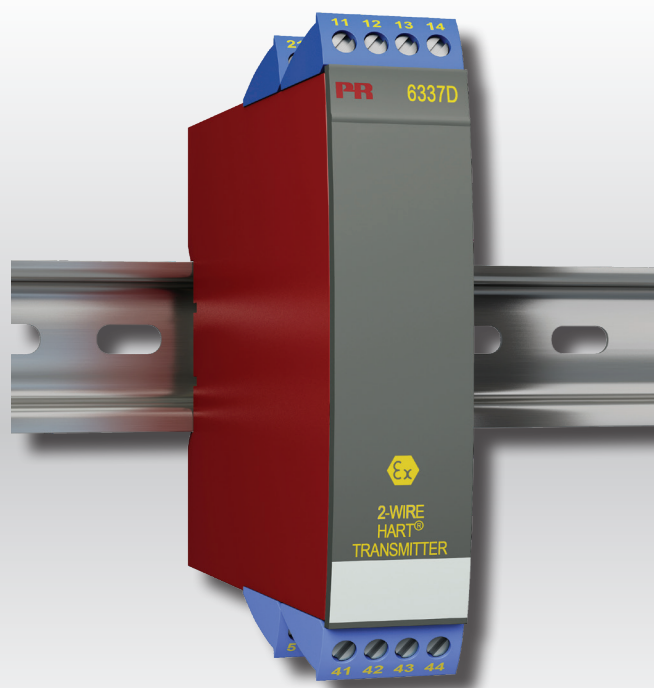

TEMPERATURE | I.S. INTERFACES | COMMUNICATION INTERFACES | MULTIFUNCTIONAL | ISOLATION | DISPLAY

No. 6337V103-UK
From serial no.: 150950564

PR
electronics

6 Product Pillars

to meet your every need

Individually outstanding, unrivalled in combination

With our innovative, patented technologies, we make signal conditioning smarter and simpler. Our portfolio is composed of six product areas, where we offer a wide range of analog and digital devices covering over a thousand applications in industrial and factory automation. All our products comply with or surpass the highest industry standards, ensuring reliability in even the harshest of environments and have a 5-year warranty for greater peace of mind.

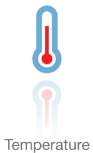

Our range of temperature transmitters and sensors provides the highest level of signal integrity from the measurement point to your control system. You can convert industrial process temperature signals to analog, bus or digital communications using a highly reliable point-to-point solution with a fast response time, automatic self-calibration, sensor error detection, low drift, and top EMC performance in any environment.



We deliver the safest signals by validating our products against the toughest safety standards. Through our commitment to innovation, we have made pioneering achievements in developing I.S. interfaces with SIL 2 Full Assessment that are both efficient and cost-effective. Our comprehensive range of analog and digital intrinsically safe isolation barriers offers multifunctional inputs and outputs, making PR an easy-to-implement site standard. Our backplanes further simplify large installations and provide seamless integration to standard DCS systems.



We provide inexpensive, easy-to-use, future-ready communication interfaces that can access your PR installed base of products. The detachable 4501 Local Operator Interface (LOI) allows for local monitoring of process values, device configuration, error detection and signal simulation. The next generation, our 4511 Remote Operator Interface (ROI) does all that and more, adding remote digital communications via Modbus/RTU, while the analog output signals are still available for redundancy.

With the 4511 you can further expand connectivity with a PR gateway, which connects via industrial Ethernet, wirelessly through a Wi-Fi router or directly with the devices using our Portable Plant Supervisor (PPS) application. The PPS app is available for iOS, Android and Windows.



Our unique range of single devices covering multiple applications is easily deployable as your site standard. Having one variant that applies to a broad range of applications can reduce your installation time and training, and greatly simplify spare parts management at your facilities. Our devices are designed for long-term signal accuracy, low power consumption, immunity to electrical noise and simple programming.



Our compact, fast, high-quality 6 mm isolators are based on microprocessor technology to provide exceptional performance and EMC-immunity for dedicated applications at a very low total cost of ownership. They can be stacked both vertically and horizontally with no air gap separation between units required.



Our display range is characterized by its flexibility and stability. The devices meet nearly every demand for display readout of process signals, and have universal input and power supply capabilities. They provide a real-time measurement of your process value no matter the industry, and are engineered to provide a user-friendly and reliable relay of information, even in demanding environments.

2-wire HART transmitter 6337

Table of contents

Technical characteristics	4
Mounting / installation	4
Applications	4
Order	5
Electrical specifications	5
Accessories	5
Changing the HART protocol version	8
Changing the HART protocol version using the PReset software and 5909 Loop Link or HART communication interface	8
Connections	11
Block diagram	12
Programming	12
Connection of transmitters in multidrop mode	14
ATEX Installation Drawing - 6337A	15
ATEX Installation Drawing - 6337D	17
IECEX Installation Drawing - 6337A	19
IECEX Installation Drawing - 6337D	21
CSA Installation Drawing - 6337D	23
FM Installation Drawing - 6337D	25
Document history	27

2-wire HART transmitter 6337

- RTD, TC, Ohm, or mV input
- 2 analog inputs and 5 device variables with status available
- HART protocol revision selectable from HART 5 or HART 7
- Hardware assessed for use in SIL applications
- Mounting on a DIN rail in safe area or hazardous gas and dust area

Application

- Linearised temperature measurement with TC and RTD sensors e.g Pt100 and Ni100.
- HART communication and 4...20 mA analog PV output for individual, difference or average temperature measurement of up to two RTD or TC input sensors.
- Conversion of linear resistance to a standard analog current signal, e.g from valves or Ohmic level sensors.
- Amplification of bipolar mV signals to standard 4...20 mA current signals.
- Up to 63 transmitters (HART 7) can be connected in a multidrop communication setup.

Technical characteristics

- HART protocol revision can be changed by user configuration to either HART 5 or HART 7 protocol.
- The HART 7 protocol offers:
 - Long Tag numbers of up to 32 characters.
 - Enhanced Burst Mode and Event notification with time stamping.
 - Device variable and status mapping to any dynamic variable PV, SV, TV or QV.
 - Process signal trend measurement with logs and summary data.
 - Automatic event notification with time stamps.
 - Command aggregation for higher communication efficiency.
- 6337 is designed according to strict safety requirements and is therefore suitable for applications in SIL installations.
- Continuous check of vital stored data.
- Meeting the NAMUR NE 21 recommendations, the 6337 HART transmitter ensures top measurement performance in harsh EMC environments. Additionally, the 6337 meets NAMUR NE43 and NE89 recommendations.

Mounting / installation

- DIN rail mounting with up to 84 channels per metre.
- Configuration via standard HART communication interfaces or by PR 5909 Loop Link.
- The 6337D can be mounted in zone 0, 1, 2 and zone 20, 21, 22 including M1 / Class I/II/ III, Division 1, Groups A, B, C, D.

Applications

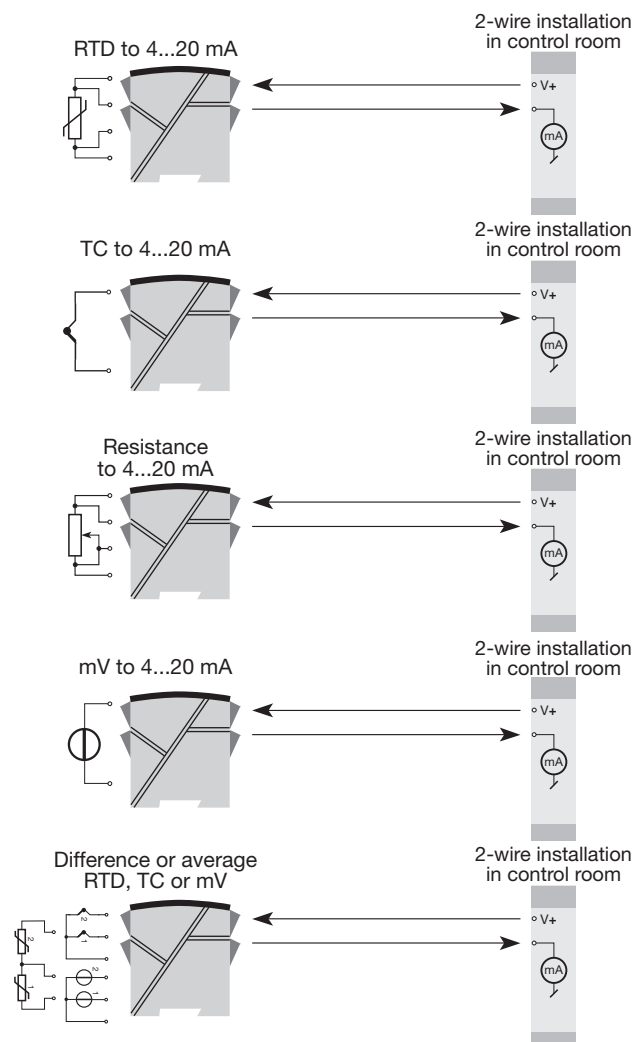

Order

Type	Version	Galvanic isolation	Channels
6337	Standard : A	1500 VAC : 2	Single : A
	ATEX, CSA, FM & IECEx : D		Double : B

Accessories

5909 = Loop Link USB interface
 5910 / 5910Ex = CJC connector for channel 1
 5913 / 5913Ex = CJC connector for channel 2

Electrical specifications

Environmental conditions:

Specification range -40°C to +85°C
 Storage temperature -40°C to +85°C
 Calibration temperature. 20...28°
 Humidity. < 95% RH (non-cond.)
 Protection degree IP20

Mechanical specifications:

Dimensions (H x W x D) 109 x 23.5 x 104 mm
 Weight (1 / 2 channels) 150 / 200 g
 DIN rail type. DIN EN/IEC 60715 - 35 mm
 Wire size. 0.13...2.08 mm² / AWG 26...14 stranded wire
 Screw terminal torque. 0.5 Nm

Common specifications:

Supply voltage, DC
 Standard. 8.0...35 V
 ATEX, CSA, FM & IECEx 8.0...30 VDC
 Internal consumption 0.19...0.8 W
 Voltage drop 8.0 VDC
 Isolation voltage, test / operation. 1.5 kVAC / 50 VAC
 Warm-up time. 30 s
 Communications interface Loop Link & HART
 Signal / noise ratio > 60 dB
 Response time (programmable) 1...60 s
 EEPROM error check < 10 s
 Signal dynamics, input 22 bit
 Signal dynamics, output 16 bit
 Effect of supply voltage variation. < 0.005% of span / VDC

Accuracy, the greater of general and basic values:

General values		
Input type	Absolute accuracy	Temperature coefficient
All	$\leq \pm 0.05\%$ of span	$\leq \pm 0.005\%$ of span / °C

Basic values		
Input type	Basic accuracy	Temperature coefficient
Pt50 - Pt1000	$\leq \pm 0.1^\circ\text{C}$	$\leq \pm 0.005^\circ\text{C}/^\circ\text{C}$
Ni50 - Ni1000	$\leq \pm 0.2^\circ\text{C}$	$\leq \pm 0.005^\circ\text{C}/^\circ\text{C}$
Lin. R	$\leq \pm 0.1 \Omega$	$\leq \pm 5 \text{ m}\Omega / ^\circ\text{C}$
Volt	$\leq \pm 10 \mu\text{V}$	$\leq \pm 0.5 \mu\text{V} / ^\circ\text{C}$
TC type: E, J, K, L, N, T, U	$\leq \pm 0.5^\circ\text{C}$	$\leq \pm 0.025^\circ\text{C} / ^\circ\text{C}$
TC type: B ¹ , Lr, R, S, W3, W5	$\leq \pm 1^\circ\text{C}$	$\leq \pm 0.1^\circ\text{C} / ^\circ\text{C}$
TC type: B ²	$\leq \pm 3^\circ\text{C}$	$\leq \pm 0.3^\circ\text{C} / ^\circ\text{C}$
TC type: B ³	$\leq \pm 8^\circ\text{C}$	$\leq \pm 0.8^\circ\text{C} / ^\circ\text{C}$
TC type: B ⁴	not specified	not specified

TC B¹ accuracy specification range > 400°C
 TC B² accuracy specification range > 160°C < 400°C
 TC B³ accuracy specification range > 85°C < 160°C
 TC B⁴ accuracy specification range < 85°C

TC cold junction compensation. < ±1.0°C
 Max. offset on input signal 50% of selec. max. value

EMC - immunity influence.	< ±0.1% of span
Extended EMC immunity: NAMUR NE 21, A criterion, burst	< ±1% of span

Input specifications:

RTD input types:

RTD type	Min. value	Max. value	Min. span	Standard
Pt100	-200°C	+850°C	10°C	IEC 60751
Ni100	-60°C	+250°C	10°C	DIN 43760
Lin. R	0 Ω	7000 Ω	25 Ω	----

Pt50, Pt100, Pt200, Pt500, Pt1000, Ni50, Ni100, Ni120, Ni1000
 Cable resistance per wire (max.). 5 Ω
 (up to 50 Ω per wire is possible with reduced measurement accuracy)
 Sensor current Nom. 0.2 mA

TC input types:

Type	Min. temperature	Max. temperature	Min. span	Standard
B	0°C	+1820°C	100°C	IEC584
E	-100°C	+1000°C	50°C	IEC584
J	-100°C	+1200°C	50°C	IEC584
K	-180°C	+1372°C	50°C	IEC584
L	-200°C	+900°C	50°C	DIN 43710
Lr	-200°C	+800°C	50°C	GOST 3044-84
N	-180°C	+1300°C	50°C	IEC584
R	-50°C	+1760°C	100°C	IEC584
S	-50°C	+1760°C	100°C	IEC584
T	-200°C	+400°C	50°C	IEC584
U	-200°C	+600°C	50°C	DIN 43710
W3	0°C	+2300°C	100°C	ASTM E988-90
W5	0°C	+2300°C	100°C	ASTM E988-90

Cold junction compensation (CJC):

Constant, internal or external via a Pt100 or Ni100 sensor

mV input:

Measurement range -800...+800 mV
 Min. span 2.5 mV
 Input resistance 10 MΩ

Output specifications and HART:

Signal range. 4...20 mA
 Min. signal range. 16 mA
 Updating time 440 ms
 Load resistance. $\leq (V_{\text{supply}} - 8) / 0.023 [\Omega]$
 Sensor error detection, programmable 3.5...23 mA
 (shorted sensor error detection is ignored at TC and mV input)
 NAMUR NE43 Upscale 23 mA
 NAMUR NE43 Downscale. 3.5 mA
 HART protocol revisions. HART 5 and HART 7

Of span = Of the presently selected range

Approvals:

EMC 2004/108/EC. EN 61326-1
 EAC TR-CU 020/2011. EN 61326-1

Ex / I.S.:

ATEX 94/9/EC KEMA 09ATEX0148 X
 CSA 1125003
 FM 2D5A7
 IECEx. IECEx KEM 10.0084 X
 EAC Ex TR-CU 012/2011 RU C-DK.GB08.V.00410

Functional safety:

Hardware assessed for use in SIL applications
 FMEDA-report - www.prelectronics.com

Changing the HART protocol version

It is possible to change the unit's HART protocol revision by using the PReset software and a PR 5909 Loop Link interface or a HART interface.

Other HART configuration tools like a Handheld HART Terminal may also be used.

Procedure for using a HART hand-held terminal to change the 6337 from HART 7 to HART 5 and vice versa:

Change the 6337 from HART 7 to HART 5:

Drive the 6337 device **Online** and enter **Device setup - Diag/Service**.

Select **Write protection** and **Write protect** by entering "*****" (8 stars).

Select **New password** - type "*****" (8 stars) & then "HARTREV5".

Select **Write enable** by entering "-CHANGE-".

Change the 6335 (6337) from HART 5 to HART 7:

Drive the 6335 device **Online** and enter **Device setup - Diag/Service**.

Select **Write protection** and **Write protect** by entering "*****" (8 stars).

Select **New password** - type "*****" (8 stars) & then "HARTREV7".

Select **Write enable** and enter "-CHANGE-".

Please note this is only possible if the transmitter is marked "6337" on the label!

Changing the HART protocol version using the PReset software and 5909 Loop Link or HART communication interface

Switching from HART 7 to HART 5:

Select the 6337 product, click the "HART" tab and open the folder "Methods".

Click "Device Password / Write Protection / Protocol..." and select "Change protocol to HART 5" in the pop-up window, then acknowledge by pressing OK.

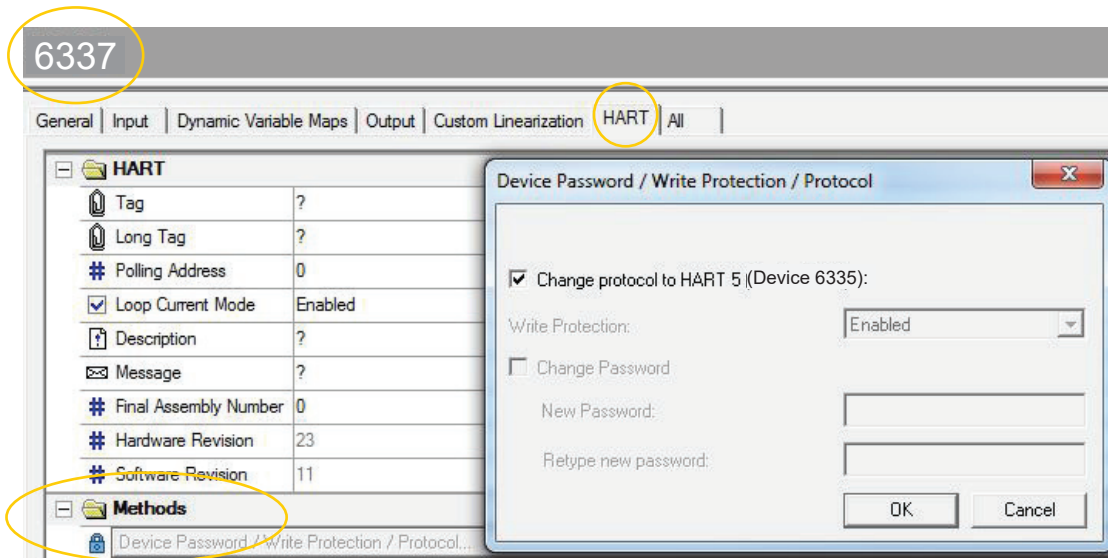

The following message will now appear:

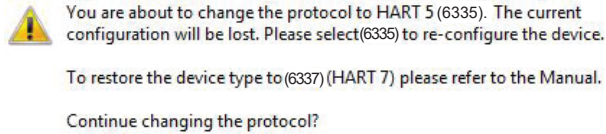

If you press "Ja" (Yes):

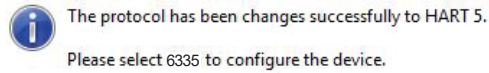

Switching from HART 5 to HART 7:

Please note this is only possible if the transmitter is marked "6337" on the label!

From PReset, select the 6335 product, click the "OPTIONS" tab click "Protect". Write protection must be set to "ON". Select **Change Password**. Type in the **New Password "HARTREV7"** and Re-enter "HARTREV7". Click OK.

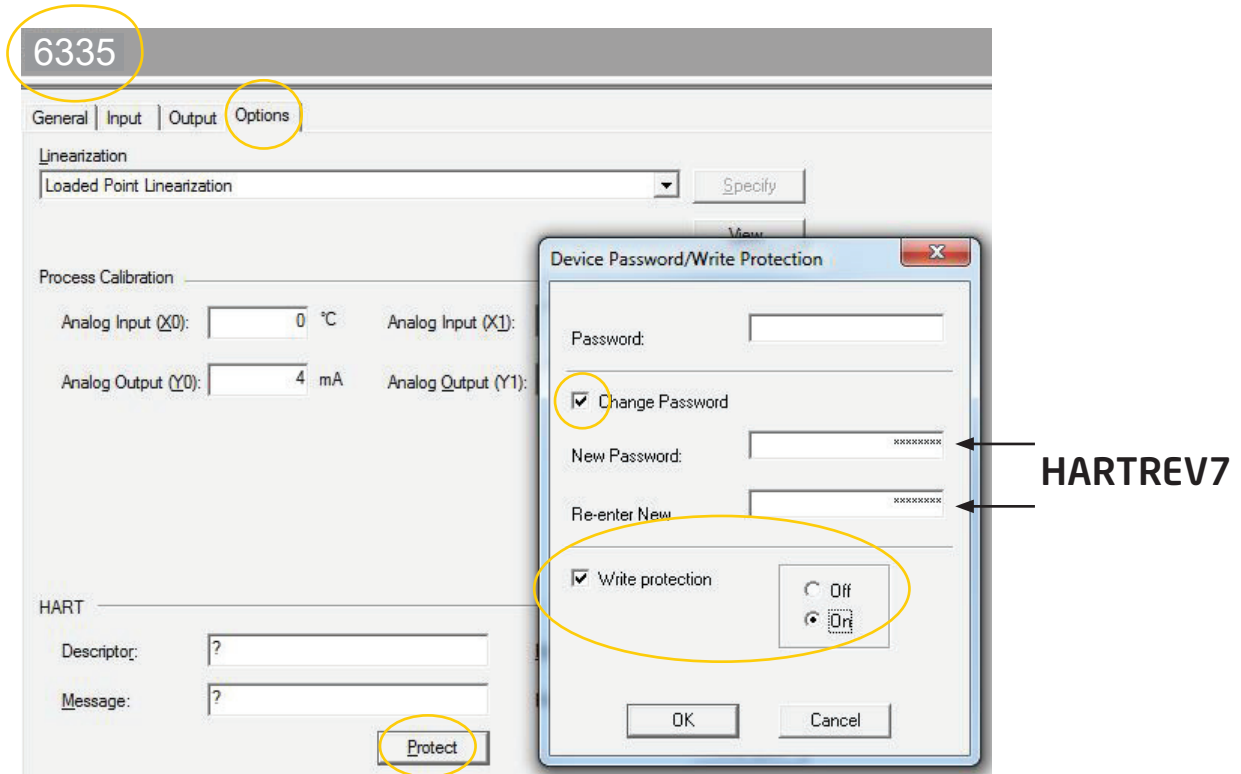

Switch **Write protection OFF** and write-enable the device by typing in the **Password "-CHANGE-"** in the top menu - acknowledge by pressing OK.

This action will reset the password to the default active password "*****" (8 stars) and restart the device in the updated HART 7 mode with write protection disabled. Now, select 6337 in PReset and reconfigure the device.

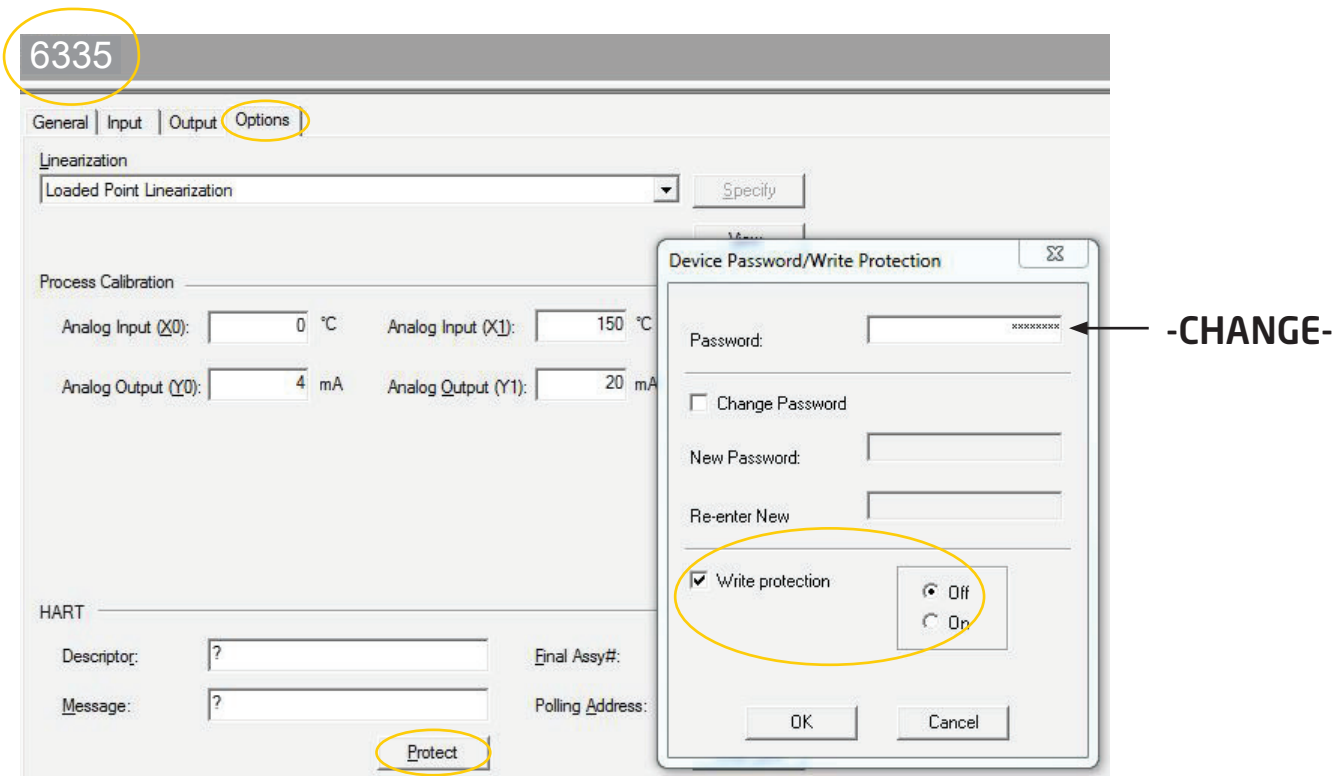

Connections

Inputs:

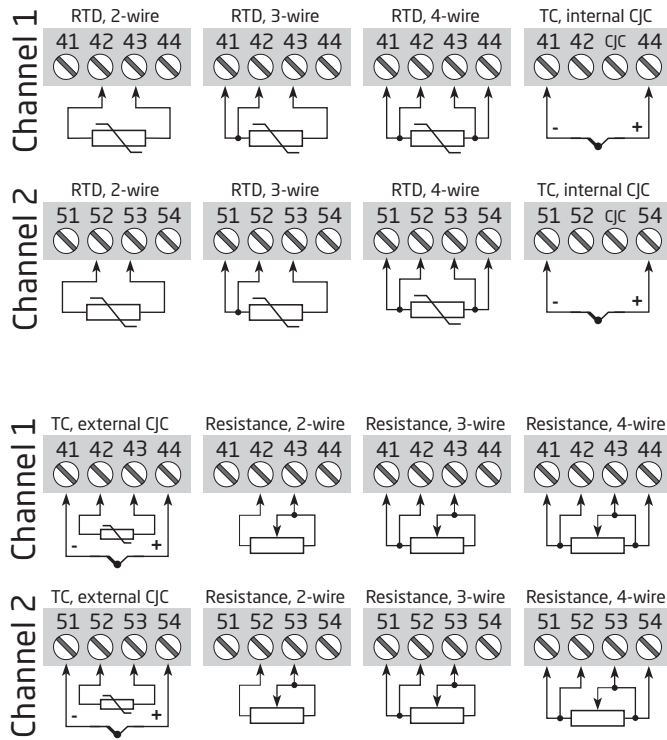

Inputs:

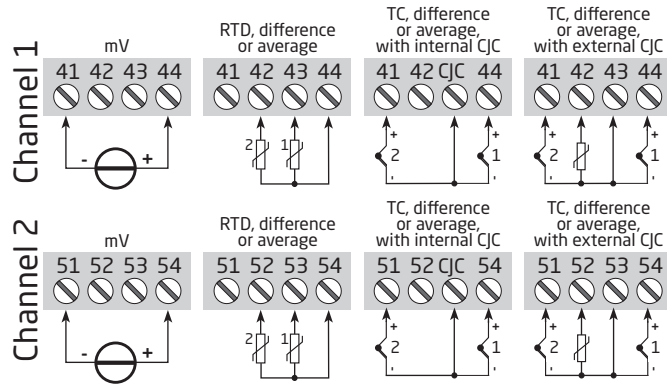

Outputs:

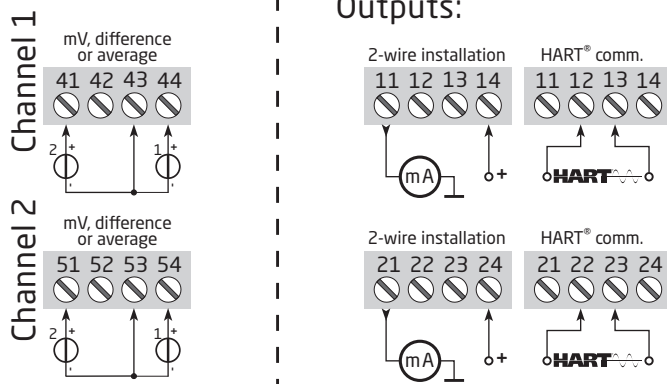

Block diagram

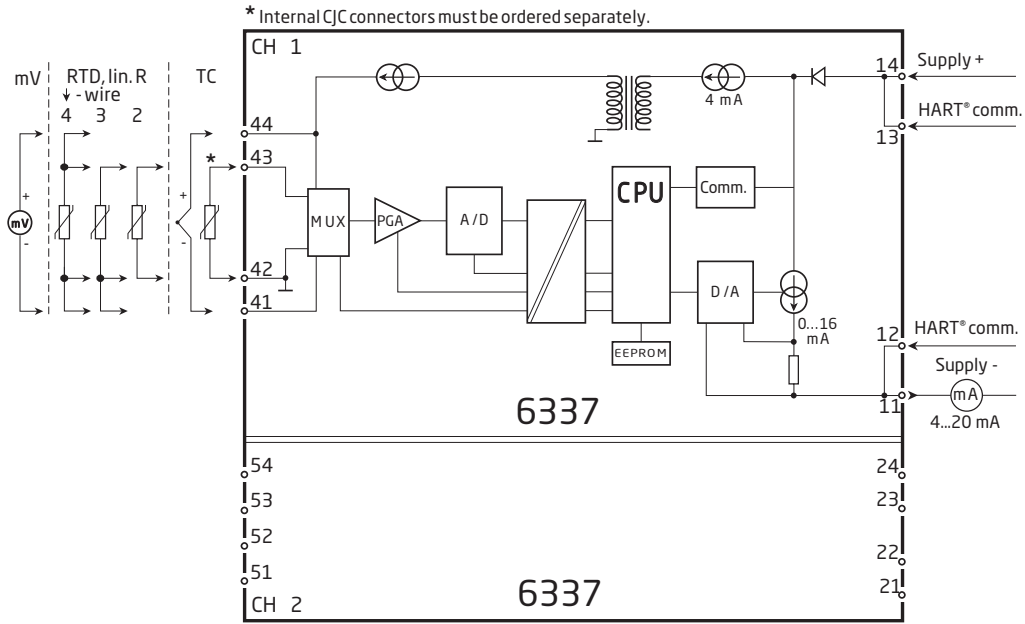

Programming

6337 can be configured in the following 3 ways:

1. With PR electronics A/S' communications interface Loop Link and PReset PC configuration software.
2. With a HART modem and PReset PC configuration software.
3. With a HART communicator with PR electronics A/S' DDL driver.

1: Loop Link

For programming please refer to the drawing below and the help functions in PReset.

When communicating with non-installed devices, connectors 11, 12, 13, 14 (channel 1) and 21, 22, 23, 24 (channel 2) can be dismantled in the safe area to connect the terminals of the communications interface to the pins.

Loop Link is not approved for communication with devices installed in hazardous (Ex) area.

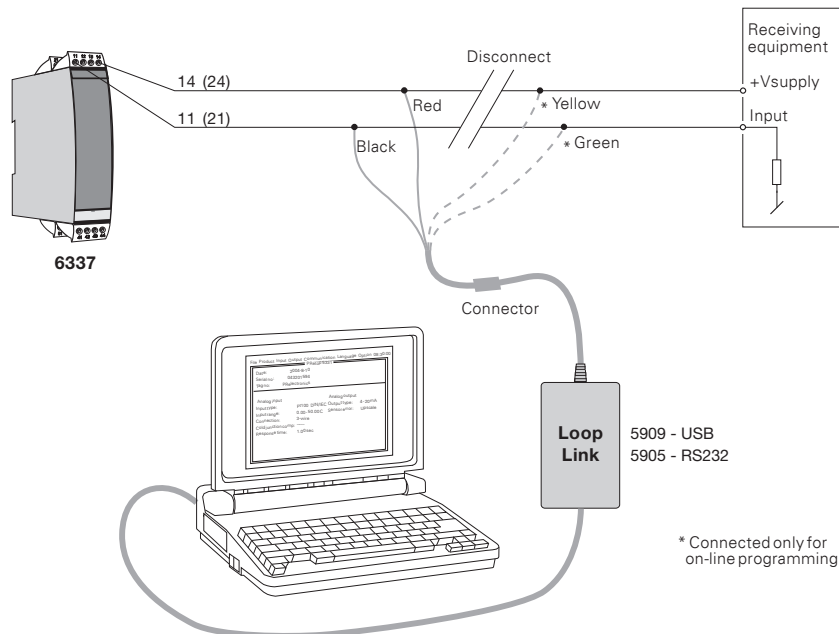

Connection of transmitters in multidrop mode

- The HART communicator or a PC modem can be connected across AB or BC.

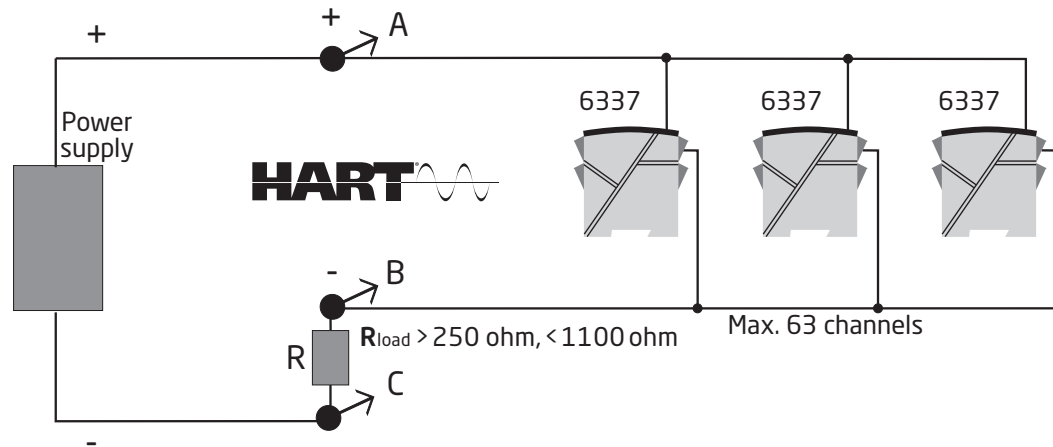

- The outputs of max. 63 transmitters can be connected in parallel for a digital HART communication on 2-wires.
- Before it is connected, each transmitter must be configured with a unique number from 1 to 63. If 2 transmitters are configured with the same number, both will be excluded. The transmitters must be programmed for multidrop mode (with a fixed output signal of 4 mA). Maximum current in the loop is therefore 252 mA.
- The communication is either by means of a HART communicator or a HARTmodem.
- The PReset PC configuration software can configure the individual transmitter for multidrop mode and provide it with a unique polling address.

ATEX Installation drawing



For safe installation of 6335A or 6337A the following must be observed. The module shall only be installed by qualified personnel who are familiar with the national and international laws, directives and standards that apply to this area.

Year of manufacture can be taken from the first two digits in the serial number.

ATEX Certificate KEMA 09ATEX0148X

Marking



II 3 G Ex nA [ic] IIC T6..T4 Gc
 II 3 G Ex ic IIC T6..T4 Gc
 II 3 D Ex ic IIIC Dc

Standards EN 60079-0 :2012, EN 60079-11:2012, EN 60079-15:2010

T6: -40°C to 60 °C
 T4: -40°C to 85 °C

Hazardous Area Zone 2 or Zone 22

Terminal:
41,42,43,44 /
51,52,53,54

Ex nA [ic]
 Uo: 9.6 VDC
 Io: 28 mA
 Po: 67.2 mW
 Lo: 45 mH
 Co: 28 µF

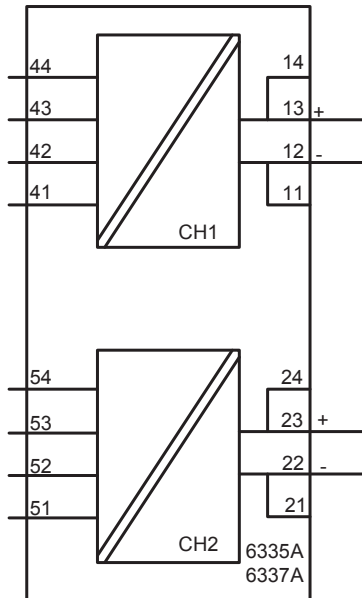

Terminal:
11,12,13,14
21,22,23,24

Ex nA
 Umax ≤ 35 VDC

Ex ic
 Ui = 35 VDC
 Li = 10 µH
 Ci = 1.0 nF

General installation instructions

To avoid risk of ignition during installation and maintenance appropriate safety measures against electrostatic discharge (ESD) are to be considered.

The sensor circuit is not infallibly galvanic isolated from the supply output circuit. However, the galvanic isolation between the circuits is capable of withstanding a test voltage of 500Vac during 1 minute.

For installation in a potentially explosive gas atmosphere, the following instructions apply:

If the transmitter is applied in type of protection “Ex nA”, it shall be installed in an enclosure that is Ex nA certified according to IEC-EN 60079-15, or “Ex e” certified and suitable for the application and correctly installed.

Cable entry devices and blanking elements shall fulfill the same requirements

For installation in a potentially explosive dust atmosphere, the following instructions apply:

If the transmitter is supplied with an intrinsically safe signal "ic" and interfaces an intrinsically safe signal "ic" (e.g. a passive device), the transmitter shall be mounted in a metal enclosure that provides a degree of protection of at least IP6X according to EN/IEC 60529, and that is suitable for the application. Cable entry devices and blanking elements shall fulfill the same requirements. The surface temperature of the enclosure is equal to the ambient temperature +20K for a dust layer with a maximum thickness of 5 mm.

General installation instructions

To avoid risk of ignition during installation and maintenance appropriate safety measures against electrostatic discharge (ESD) are to be considered.

The sensor circuit is not infallibly galvanic isolated from the supply output circuit. However, the galvanic isolation between the circuits is capable of withstanding a test voltage of 500Vac during 1 minute.

For installation in a potentially explosive gas atmosphere the following instructions apply:

To avoid risk of ignition due to electrostatic discharge (ESD) the transmitter shall be mounted in an enclosure providing a degree of protection of at least IP20 according to EN/IEC 60529.

Ambient temperature range:

T4: $-40 \leq T_a \leq 85^{\circ}\text{C}$

T5: $-40 \leq T_a \leq 60^{\circ}\text{C}$

T6: $-40 \leq T_a \leq 40^{\circ}\text{C}$

For installation in a potentially explosive dust atmosphere, the following instructions apply:

The transmitter shall be mounted in a metal enclosure or equivalent that is providing a degree of protection of at least IP6X according to EN/IEC 60529 that is suitable for the application and correctly installed. Cable entries and blanking elements shall be used that are suitable for the application and correctly installed. The surface temperature of the enclosure is equal to the ambient temperature +20K for a dust layer with a maximum thickness of 5 mm.

Ambient temperature range:

T4: $-40 \leq T_a \leq 85^{\circ}\text{C}$

For installation in a potentially explosive atmosphere in mines, the following instructions apply:

The transmitter shall be mounted in an enclosure providing a degree of protection of at least IP6X according to EN/IEC 60529. Cable entries and blanking elements shall be used that are suitable for the application and correctly installed.

Ambient temperature range:

T4: $-40 \leq T_a \leq 85^{\circ}\text{C}$

IECEX Installation drawing

For safe installation of 6335A or 6337A the following must be observed. The module shall only be installed by qualified personnel who are familiar with the national and international laws, directives and standards that apply to this area.

Year of manufacture can be taken from the first two digits in the serial number.

IECEX Certificate IECEx KEM.10.0084X

Marking
 Ex nA [ic] IIC T6..T4 Gc
 Ex ic IIC T6..T4 Gc
 Ex ic IIIC Dc

Standards IEC60079-0: 2011, IEC60079-11:2011, IEC60079-15:2010

T6: -40°C to 60 °C
 T4: -40°C to 85 °C

Hazardous Area Zone 2 or Zone 22

**Terminal:
 41,42,43,44 /
 51,52,53,54**

Ex nA [ic]

U_o: 9.6 VDC
 I_o: 28 mA
 P_o: 67.2 mW
 L_o: 35 mH
 C_o: 3.5 µF

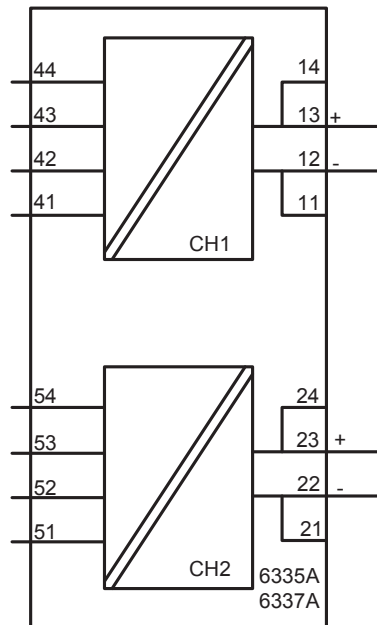

**Terminal:
 11,12,13,14
 21,22,23,24**

Ex nA
 U ≤ 35 VDC

Ex ic
 U_i : 35 VDC
 L_i : 10 µH
 C_i : 1.0 nF

General installation instructions

If the enclosure is made of non-metallic materials or of painted metal, electrostatic charging shall be avoided.

The sensor circuit is not infallibly galvanic isolated from the supply output circuit. However, the galvanic isolation between the circuits is capable of withstanding a test voltage of 500Vac during 1 minute.

For installation in a potentially explosive gas atmosphere, the following instructions apply:

If the transmitter is applied in type of protection "Ex nA", it shall be installed in an enclosure that is Ex nA certified according to IEC-EN 60079-15, or "Ex e" certified and suitable for the application and correctly installed.

Cable entry devices and blanking elements shall fulfill the same requirements

For installation in a potentially explosive dust atmosphere, the following instructions apply:

If the transmitter is supplied with an intrinsically safe signal "ic" and interfaces an intrinsically safe signal "ic" (e.g. a passive device), the transmitter shall be mounted in a metal enclosure that provides a degree of protection of at least IP6X according to EN/IEC 60529, and that is suitable for the application. Cable entry devices and blanking elements shall fulfill the same requirements. The surface temperature of the enclosure is equal to the ambient temperature +20K for a dust layer with a maximum thickness of 5 mm.

IECEX Installation drawing



For safe installation of 6335D or 6337D the following must be observed. The module shall only be installed by qualified personnel who are familiar with the national and international laws, directives and standards that apply to this area.

Year of manufacture can be taken from the first two digits in the serial number.

IECEX Certificate	IECEX KEM.10.0084X
Marking	Ex ia IIC T6..T4 Ga Ex ia IIIC Da Ex ia I Ma
Standards:	IEC60079-0:2011, IEC60079-11: 2011, IEC60079-26:2006

Hazardous area
Zone 0, 1, 2, 20, 21, 22

T4: $-40 \leq T_a \leq 85^\circ\text{C}$
T5: $-40 \leq T_a \leq 60^\circ\text{C}$
T6: $-40 \leq T_a \leq 40^\circ\text{C}$

Non Hazardous Area

**Terminal:
41,42,43,44**
Uo: 9.6 VDC
Io: 28 mA
Po: 67.2 mW
Lo: 35 mH
Co: 3.5 μF

**Terminal:
51,52,53,54**
Uo: 9.6 VDC
Io: 28 mA
Po: 67.2 mW
Lo: 35 mH
Co: 3.5 μF

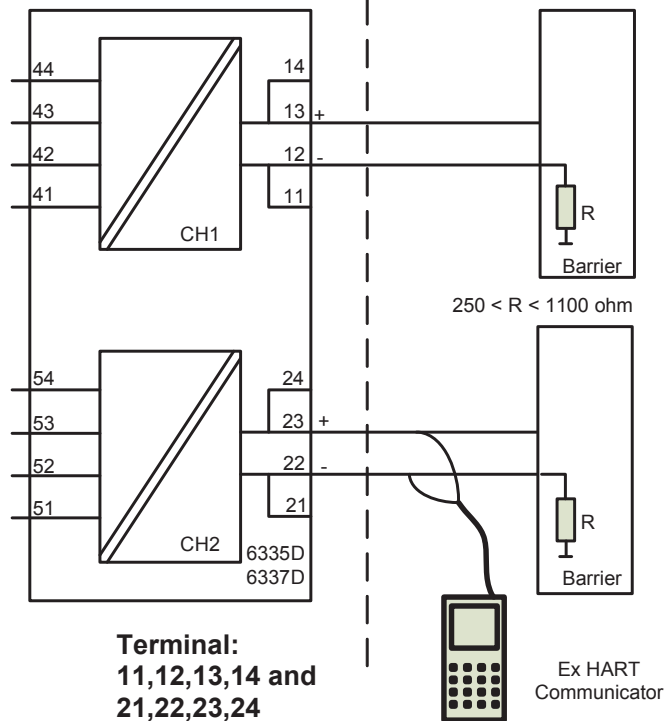

**Terminal:
11,12,13,14 and
21,22,23,24**
Ui: 30 VDC
Ii: 120 mA
Pi: 0.84 W
Li: 10 μH
Ci: 1.0 nF

General installation instructions

To avoid risk of ignition during installation and maintenance appropriate safety measures against electrostatic discharge (ESD) are to be considered.

The sensor circuit is not infallibly galvanic isolated from the supply output circuit. However, the galvanic isolation between the circuits is capable of withstanding a test voltage of 500Vac during 1 minute.

For installation in a potentially explosive gas atmosphere the following instructions apply:

To avoid risk of ignition due to electrostatic discharge (ESD) the transmitter shall be mounted in an enclosure providing a degree of protection of at least IP20 according to EN/IEC 60529.

Ambient temperature range:

T4: $-40 \leq T_a \leq 85^{\circ}\text{C}$

T5: $-40 \leq T_a \leq 60^{\circ}\text{C}$

T6: $-40 \leq T_a \leq 40^{\circ}\text{C}$

For installation in a potentially explosive dust atmosphere, the following instructions apply:

The transmitter shall be mounted in a metal enclosure or equivalent that is providing a degree of protection of at least IP6X according to EN/IEC 60529 that is suitable for the application and correctly installed. Cable entries and blanking elements shall be used that are suitable for the application and correctly installed. The surface temperature of the enclosure is equal to the ambient temperature +20K for a dust layer with a maximum thickness of 5 mm.

Ambient temperature range:

T4: $-40 \leq T_a \leq 85^{\circ}\text{C}$

For installation in a potentially explosive atmosphere in mines, the following instructions apply:

The transmitter shall be mounted in an enclosure providing a degree of protection of at least IP6X according to EN/IEC 60529. Cable entries and blanking elements shall be used that are suitable for the application and correctly installed.

Ambient temperature range:

T4: $-40 \leq T_a \leq 85^{\circ}\text{C}$

Hazardous (Classified) Location
 IS,Class I, Division 1, Group A,B,C,D T4..T6
 Ex ia IIC T4..T6 Ga
 Class I, Zone 0, AEx ia IIC T4..T6 Ga

Non Hazardous Location

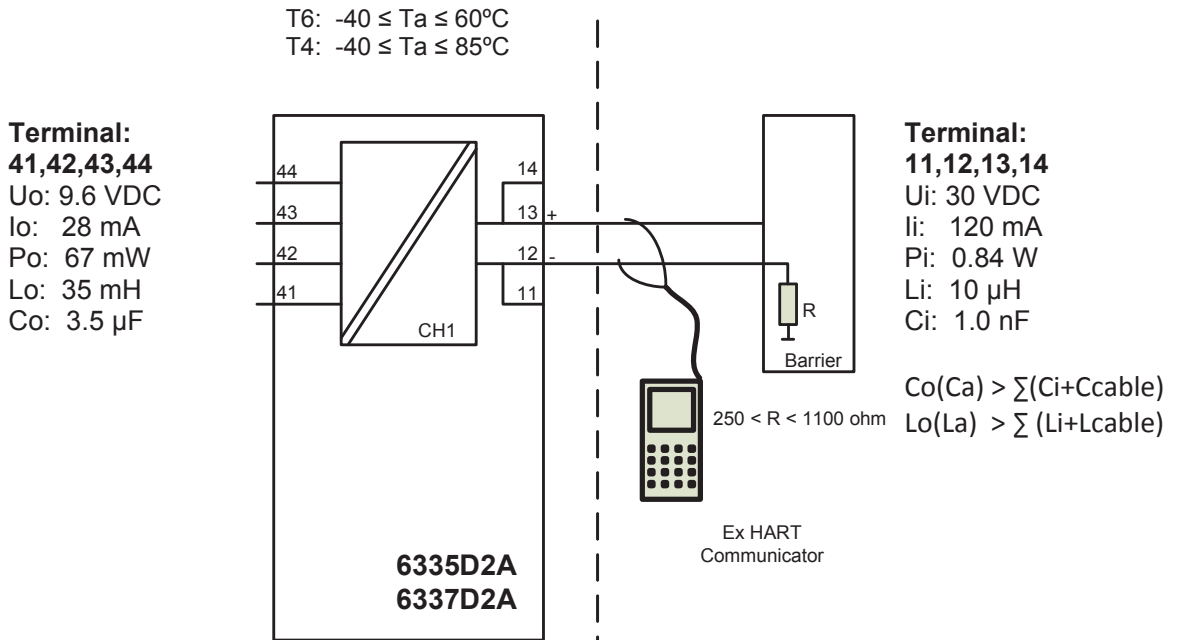

Installation notes.

The Transmitter must be installed in a suitable enclosure to meet installation codes stipulated in The Canadian Electrical Code (CEC).

Substitution of components may impair intrinsic safety.

Hazardous (Classified) Location
IS,Class I, Division 1, Group A,B,C,D T4..T6
Ex ia IIC T4..T6 Ga
Class I, Zone 0, AEx ia IIC T4..T6 Ga

Non Hazardous Location

**Terminal:
41,42,43,44**
Uo: 9.6 VDC
Io: 28 mA
Po: 67 mW
Lo: 35 mH
Co: 3.5µF

**Terminal:
51,52,53,54**
Uo: 9.6 VDC
Io: 28 mA
Po: 67 mW
Lo: 35 mH
Co: 3.5µF

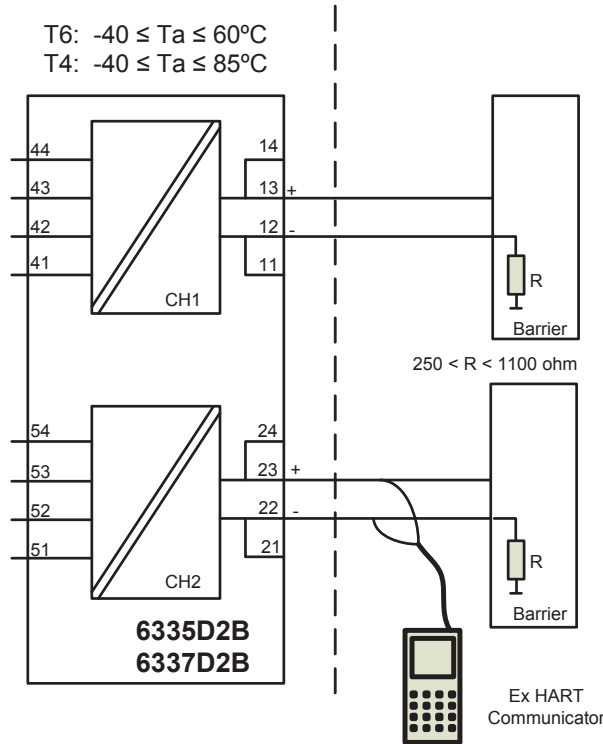

**Terminal:
11,12,13,14 and
21,22,23,24**
Ui: 30 VDC
Ii: 120 mA
Pi: 0.84 W
Li: 10µH
Ci: 1.0nF

$Co(Ca) > \sum(Ci+Ccable)$
 $Lo(La) > \sum(Li+Lcable)$

Installation notes.

The Transmitter must be installed in a suitable enclosure to meet installation codes stipulated in The Canadian Electrical Code (CEC).

Channel 1 and Channel 2 are separate channels and therefore separate shielded cables shall be used for each channel.

Substitution of components may impair intrinsic safety.

Hazardous (Classified) Location
Class I, Division 1, Group A,B,C,D T4..T6
Class I, Zone 0, AEx ia IIC T4..T6

Non Hazardous Location

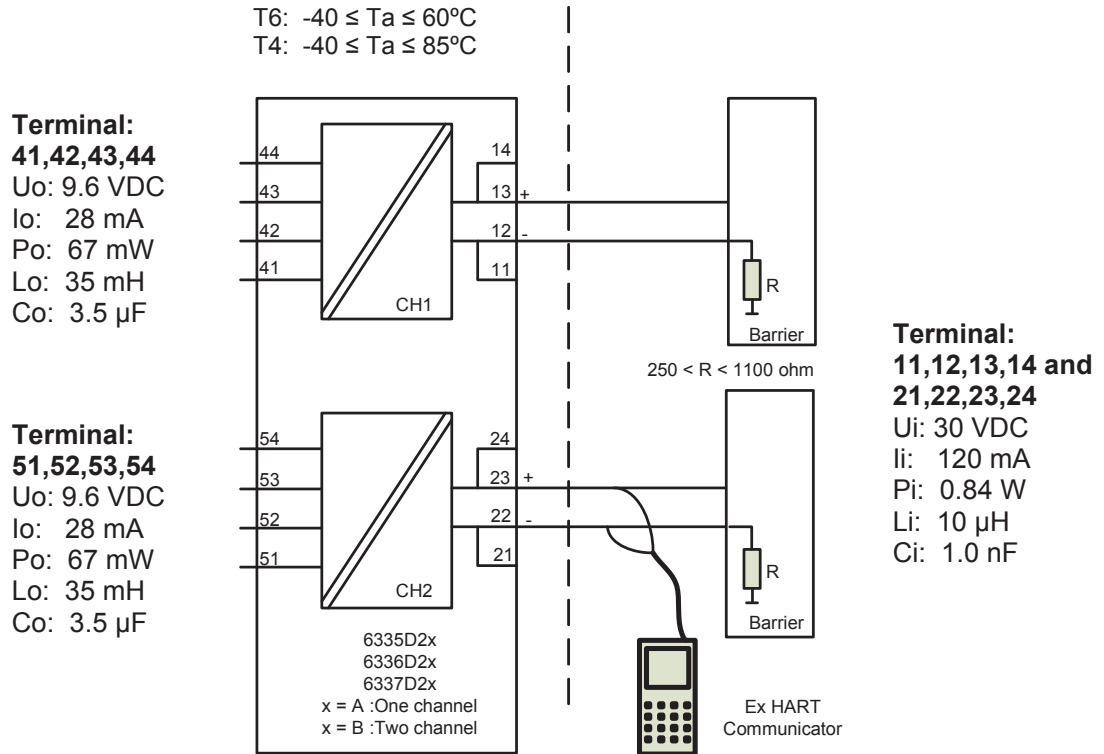

Installation notes

For installation in Class I the Transmitter must be installed in a suitable enclosure to meet installation codes stipulated in The National Electrical Code (ANSI-NFPA 70).

Equipment that is FM-approved for intrinsic safety may be connected to barriers based on the Entity Concept. This concept permits interconnection of approved transmitters, meters and other devices in combinations, which have not been specifically examined by FM, provided that the agency's criteria are met. The combination is then intrinsically safe, if the entity concept is acceptable to the authority having jurisdiction over the installation.

The entity concept criteria are as follows: The intrinsically safe devices, other than barriers, must not be a source of power. The maximum voltage $U_i(V_{MAX})$ and current $I_i(I_{MAX})$, and maximum power $P_i(P_{max})$, which the device can receive and remain intrinsically safe, must be equal to or greater than the voltage (U_o or V_{OC} or V_i) and current (I_o or I_{SC} or I_t) and the power P_o which can be delivered by the barrier. The sum of the maximum unprotected capacitance (C_i) for each intrinsically device and the interconnecting wiring must be less than the capacitance (C_a) which can be safely connected to the barrier. The sum of the maximum unprotected inductance (L_i) for each intrinsically device and the interconnecting wiring must be less than the inductance (L_a) which can be safely connected to the barrier. The entity parameters U_o , V_{OC} or V_i and I_o , I_{SC} or I_t , and C_a and L_a for barriers are provided by the barrier manufacturer.

Hazardous (Classified) Location
Class I, Division 2, Group A,B,C,D T4..T6
Class I, Zone 2, IIC T4..T6

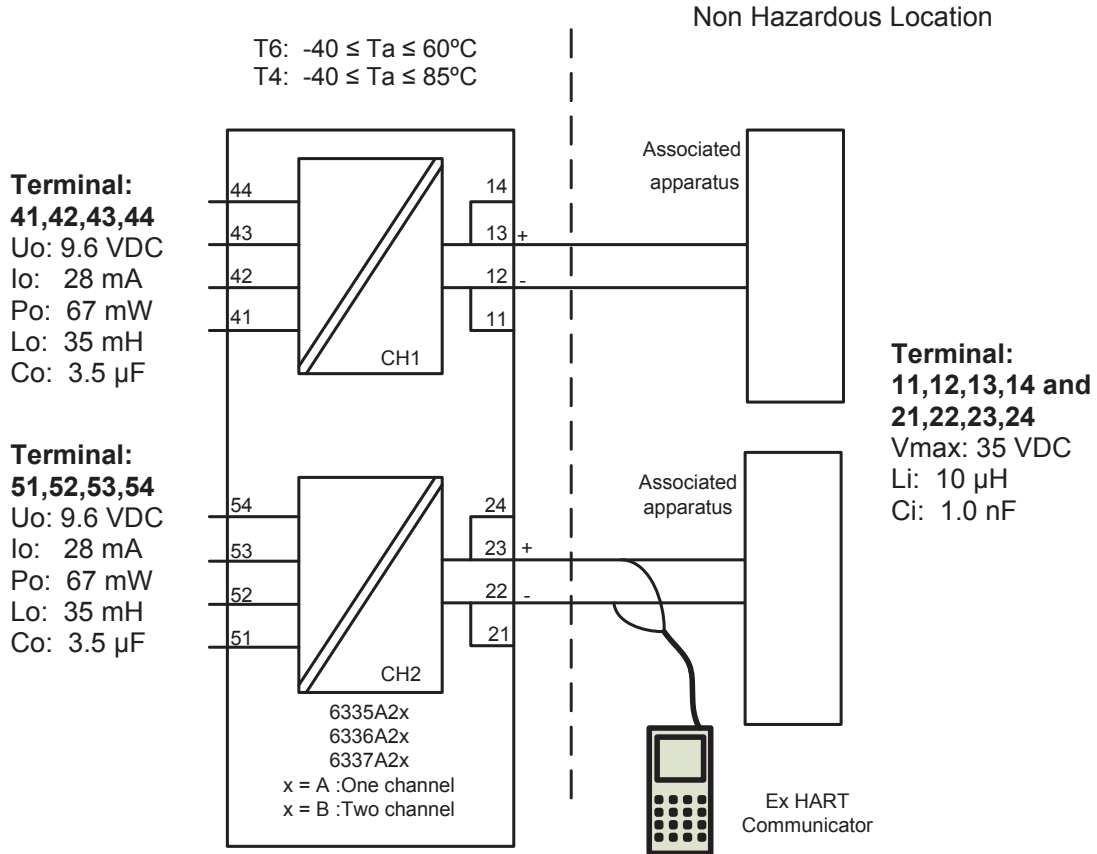

Installation notes

The Transmitter must be installed in a suitable enclosure to meet installation codes stipulated in The National Electrical Code (ANSI-NFPA 70).

To assure a Non-Incendive system the transmitter and associated apparatus must be wired in accordance with the associated apparatus manufacturers field wiring instructions and the circuit diagram shown above.

Document history

The following list provides notes concerning revisions of this document.

Rev. ID	Date	Notes
103	15/50	ATEX & IECEx M1 approval added

We are near you, *all over the world*

Our trusted red boxes are supported wherever you are

All our devices are backed by expert service and a 5-year warranty. With each product you purchase, you receive personal technical support and guidance, day-to-day delivery, repair without charge within the warranty period and easily accessible documentation.

We are headquartered in Denmark, and have offices and authorized partners the world over. We are a local business

with a global reach. This means that we are always nearby and know your local markets well.

We are committed to your satisfaction and provide PERFORMANCE MADE SMARTER all around the world.

For more information on our warranty program, or to meet with a sales representative in your region, visit prelectronics.com.

Benefit today from *PERFORMANCE MADE SMARTER*

PR electronics is the leading technology company specialized in making industrial process control safer, more reliable and more efficient. Since 1974, we have been dedicated to perfecting our core competence of innovating high precision technology with low power consumption. This dedication continues to set new standards for products communicating, monitoring and connecting our customers' process measurement points to their process control systems.

Our innovative, patented technologies are derived from our extensive R&D facilities and from having a great understanding of our customers' needs and processes. We are guided by principles of simplicity, focus, courage and excellence, enabling some of the world's greatest companies to achieve PERFORMANCE MADE SMARTER.