



5 1 1 4

**Programmable
Transmitter**

No. 5114V107-UK

From ser. no. 990061001



EAC CE

- DK** ▶ PR electronics A/S tilbyder et bredt program af analoge og digitale signalbehandlingsmoduler til industriel automation. Programmet består af Isolatorer, Displays, Ex-barrierer, Temperaturtransmittere, multifunktionelle transmittere mfl. Vi har modulerne, du kan stole på i selv barske miljøer med elektrisk støj, vibrationer og temperaturudsving, og alle produkter opfylder de strengeste internationale standarder. Vores motto »Signals the Best« er indbegrebet af denne filosofi - og din garanti for kvalitet.
- UK** ▶ PR electronics A/S offers a wide range of analog and digital signal conditioning devices for industrial automation. The product range includes Isolators, Displays, Ex Interfaces, Temperature Transmitters, and Multifunctional Devices. You can trust our products in the most extreme environments with electrical noise, vibrations and temperature fluctuations, and all products comply with the most exacting international standards. »Signals the Best« is the epitome of our philosophy - and your guarantee for quality.
- FR** ▶ PR electronics A/S offre une large gamme de produits pour le traitement des signaux analogiques et numériques dans tous les domaines industriels. La gamme de produits s'étend des transmetteurs de température aux afficheurs, des isolateurs aux interfaces SI, jusqu'aux modules multifonctions. Vous pouvez compter sur nos produits même dans les conditions d'utilisation sévères, p.ex. bruit électrique, vibrations et fluctuations de température. Tous nos produits sont conformes aux normes internationales les plus strictes. Notre devise »SIGNALS the BEST« c'est notre ligne de conduite - et pour vous l'assurance de la meilleure qualité.
- DE** ▶ PR electronics A/S verfügt über ein breites Produktprogramm an analogen und digitalen Signalverarbeitungsgeräte für die industrielle Automatisierung. Dieses Programm umfasst Displays, Temperaturtransmitter, Ex- und galvanische Signaltrenner, und Multifunktionale Geräte. Sie können unsere Geräte auch unter extremen Einsatzbedingungen wie elektrisches Rauschen, Erschütterungen und Temperaturschwingungen vertrauen, und alle Produkte von PR electronics werden in Übereinstimmung mit den strengsten internationalen Normen produziert. »Signals the Best« ist Ihre Garantie für Qualität!

PROGRAMMABLE TRANSMITTER

5114

CONTENTS

Warning.....	2
Symbol identification	3
Safety instructions.....	3
How to demount system 5000	5
Application.....	6
Technical characteristics.....	6
Input types	6
Output	7
Configuration.....	8
Electrical specifications.....	8
Order	13
5114 connection to Loop Link	13
Block diagram.....	14
Selection of input type: (5114A).....	15



GENERAL

WARNING

This device is designed for connection to hazardous electric voltages. Ignoring this warning can result in severe personal injury or mechanical damage.

To avoid the risk of electric shock and fire, the safety instructions of this manual must be observed and the guidelines followed. The specifications must not be exceeded, and the device must only be applied as described in the following.

Prior to the commissioning of the device, this manual must be examined carefully. Only qualified personnel (technicians) should install this device. If the equipment is used in a manner not specified by the manufacturer, the protection provided by the equipment may be impaired.



**HAZARDOUS
VOLTAGE**

WARNING

Until the device is fixed, do not connect hazardous voltages to the device.

The following operations should only be carried out on a disconnected device and under ESD safe conditions:

Dismantlement of the device for setting of DIP-switches and jumpers.

General mounting, connection and disconnection of wires.

Troubleshooting the device.



Repair of the device and replacement of circuit breakers must be done by PR electronics A/S only.



**INSTAL-
LATION**

WARNING

SYSTEM 5000 must be mounted on DIN rail according to DIN 46277.

The communication connector of SYSTEM 5000 is connected to the input terminals on which dangerous voltages can occur, and it must only be connected to the programming unit Loop Link by way of the enclosed cable.

SYMBOL IDENTIFICATION



Triangle with an exclamation mark: Warning / demand.
Potentially lethal situations.



The **CE mark** proves the compliance of the device with the essential requirements of the directives.



The **double insulation** symbol shows that the device is protected by double or reinforced insulation.



Ex devices have been approved for use in connection with installations in explosive areas.

SAFETY INSTRUCTIONS

DEFINITIONS

Hazardous voltages have been defined as the ranges: 75 to 1500 Volt DC, and 50 to 1000 Volt AC.

Technicians are qualified persons educated or trained to mount, operate, and also troubleshoot technically correct and in accordance with safety regulations.

Operators, being familiar with the contents of this manual, adjust and operate the knobs or potentiometers during normal operation.

RECEIPT AND UNPACKING

Unpack the device without damaging it. The packing should always follow the device until this has been permanently mounted. Check at the receipt of the device whether the type corresponds to the one ordered.

ENVIRONMENT

Avoid direct sunlight, dust, high temperatures, mechanical vibrations and shock, as well as rain and heavy moisture. If necessary, heating in excess of the stated limits for ambient temperatures should be avoided by way of ventilation.

All devices fall under Installation Category II, Pollution Degree 1, and Insulation Class II.

MOUNTING

Only technicians who are familiar with the technical terms, warnings, and instructions in the manual and who are able to follow these should connect the device. Should there be any doubt as to the correct handling of the device, please contact your local distributor or, alternatively,

PR electronics A/S
www.prelectronics.com

Mounting and connection of the device should comply with national legislation for mounting of electric materials, i.e. wire cross section, protective fuse, and location. Descriptions of input / output and supply connections are shown in the block diagram and side label.

The following apply to fixed hazardous voltages-connected devices:

The max. size of the protective fuse is 10 A and, together with a power switch, it should be easily accessible and close to the device. The power switch should be marked with a label telling it will switch off the voltage to the device.

Year of manufacture can be taken from the first two digits in the serial number.

CALIBRATION AND ADJUSTMENT:

During calibration and adjustment, the measuring and connection of external voltages must be carried out according to the specifications of this manual. The technician must use tools and instruments that are safe to use.

NORMAL OPERATION:

Operators are only allowed to adjust and operate devices that are safely fixed in panels, etc., thus avoiding the danger of personal injury and damage. This means there is no electrical shock hazard, and the device is easily accessible.

CLEANING:

When disconnected, the device may be cleaned with a cloth moistened with distilled water.

LIABILITY:

To the extent the instructions in this manual are not strictly observed, the customer cannot advance a demand against PR electronics A/S that would otherwise exist according to the concluded sales agreement.

HOW TO DEMOUNT SYSTEM 5000

First, remember to demount the connectors with hazardous voltages. By lifting the bottom lock, the device is detached from the DIN rail as shown in picture 1. Then, by lifting the upper lock and pulling the front plate simultaneously the PCB is removed as shown in picture 2. Switches and jumpers can now be adjusted. By opening the front, the programming connector is accessible as shown in picture 3.

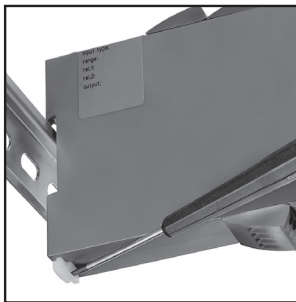

Picture 1: Separation from DIN rail.

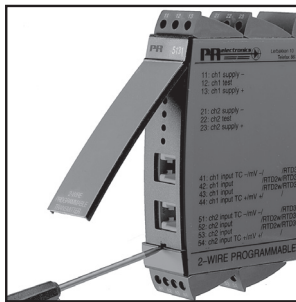

Picture 3: Access to programming connector.

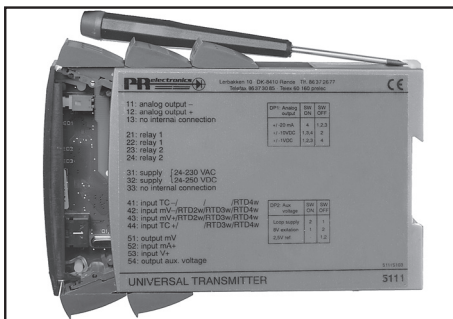

Picture 2: Removal of PCB.

PROGRAMMABLE TRANSMITTER 5114

- Input for RTD, TC, mV, linear resistance, mA, and V
- 3-port 3.75 kVAC galvanic isolation
- Current and voltage output
- Universal voltage supply
- 1- and 2-channel versions
- Loop supply > 17.1 V in Ex zone 0

APPLICATION

Electronic temperature measurement with resistance sensor or thermocouple sensor. • Ex barrier for temperature sensors, potentiometers, and current / voltage signals • Ex power supply for 2-wire transmitters in zone 0, 1, 2, 20, 21, and 22. • Amplification of mV signals. • Conversion of linear resistance variation. • Galvanic isolation of analogue signals. • Measurement of floating signals. • Linearisation of non-linear Ohm, mV, mA, or voltage signals. • Separation of circuits in PELV/SELV installations. • The transmitter is especially suitable for emitting the output current signal, either as a standard current signal or as a loop signal.

TECHNICAL CHARACTERISTICS

The unit is based on a microprocessor core with an efficient program operation. The basic calibration data and present set-up are stored in an EEPROM thereby avoiding the loss or change of data at power off. The 2-channel version has a full galvanic isolation between the channels. By way of jumpers on the PCB the input in the standard version can be programmed either for a temperature or a current / voltage input. This means that one channel can work as for instance a temperature transmitter and the other can work as an isolation amplifier. Measurement range, signal parameters, and output span are configured to the present task by way of a PC and PR electronics A/S' communications interface Loop Link.

INPUT TYPES

Temperature input - jumpers in position 1:

Thermocouple input (TC) for standard thermocouples type B, E, J, K, L, N, R, S, T, U, W3, W5, LR according to the norms IEC 584, DIN 43710, ASTM E988-90 and GOST 3044-84. The CJC can be selected in 3 different ways: internally in the terminal, externally by way of a Pt100 / Ni100 sensor, or externally with a constant temperature.

If internal compensation is selected, a terminal with a built-in temperature sensor must be ordered separately (PR type no. 5910 and 5913). Sensor error detection is available.

RTD input for Pt100...Pt1000 according to the norm IEC 751 and Ni100...Ni1000 according to the norm DIN 43760.

Automatic cable compensation at a 3- or 4-wire connection. At a 2-wire connection the cable resistance can be entered or measured by the configuration program and sent to the device which then compensates by the entered cable resistance. Sensor error detection is available.

Resistance input for resistance measurement with cable compensation as described under the RTD input. Sensor error detection is available.

The mV input is programmable in the range -150...+150 mV.

Current / voltage input - jumpers in position 2:

The current input is programmable in the range 0...100 mA, for instance 4...20 mA.

The voltage input is programmable in the range 0...250 VDC.

Auxiliary supplies are selected in the configuration program:

Loop transmitter supply > 17.1 VDC.

Reference voltage of 2.5 VDC, for instance as a supply for potentiometers.

OUTPUT

The analogue standard current / voltage output is programmable in the range 0...20 mA, for instance 4...20 mA and 0...10 VDC. The output voltage can be ordered for a maximum of 12 VDC by a special shunt resistance. The output signal is proportional and linear to the value of the input signal. Special set-ups can be selected in the configuration program, for instance a customised linearisation, a reversed output, a limiter according to the selected output span, and selection of an output value in case of a sensor error. Maximum load on the current output is 600 Ω . Minimum load on the voltage output is 500 k Ω .

Loop 4...20 mA current output:

By wiring the current signal alternatively, the output works as a loop output. If the supply voltage for the 5114 disappears, the output current drops to < 4 mA.

Sensor error detection:

The output can be set up at an RTD, thermocouple and linear resistance input to go *to max.*, *to min.* or *entered value* at sensor error detection. If the output is set to 4...20 mA it is also possible to select NAMUR NE43 Upscale or Downscale.

CONFIGURATION

The transmitter is configured to the present task by way of a PC and PR electronics A/S' communications interface Loop Link. The communications interface is galvanically isolated to protect the PC port. Communication is 2-way to allow the retrieval of the transmitter set-up into the PC and to allow the transmission of the PC set-up to the transmitter. For users who do not wish to do the set-up themselves, the 5114 can be delivered configured according to customer specifications: input type, measurement range, sensor error detection, and output signal.

ELECTRICAL SPECIFICATIONS

Specifications range:

-20°C to +60°C

Common specifications:

Supply voltage, universal	21.6...253 VAC
	50...60 Hz
	19.2...300 VDC
Max. required power, 1 / 2 channels	2.1 W / 2.8 W
Fuse.....	400 mA SB / 250 VAC
Isolation voltage, test / operation	3.75 kVAC / 250 VAC
PELV/SELV	IEC 61140
Communications interface	Loop Link
Signal / noise ratio	Min. 60 dB (0...100 kHz)
Updating time:	
Temperature input.....	115 ms
mA / V / mV input.....	75 ms
Response time (0...90%, 100...10%), programmable:	
Temperature input.....	400 ms...60 s
mA / V / mV input.....	250 ms...60 s
Signal dynamics, input.....	22 bit
Signal dynamics, output	16 bit
Calibration temperature	20...28°C

Accuracy, the greater of the general and basic values:

General values		
Input type	Absolute accuracy	Temperature coefficient
All	$\leq \pm 0.05\%$ of span	$\leq \pm 0.01\%$ of span / °C

Basic values		
Input type	Basic accuracy	Temperature coefficient
mA	$\leq \pm 4 \mu\text{A}$	$\leq \pm 0.4 \mu\text{A} / ^\circ\text{C}$
Volt	$\leq \pm 10 \mu\text{V}$	$\leq \pm 1 \mu\text{V} / ^\circ\text{C}$
RTD	$\leq \pm 0.2^\circ\text{C}$	$\leq \pm 0.01^\circ\text{C} / ^\circ\text{C}$
Lin. resistance	$\leq \pm 0.1 \Omega$	$\leq \pm 10 \text{m}\Omega / ^\circ\text{C}$
TC type: E, J, K, L, N, T, U	$\leq \pm 1^\circ\text{C}$	$\leq \pm 0.05^\circ\text{C} / ^\circ\text{C}$
TC type: B, R, S, W3, W5, LR	$\leq \pm 2^\circ\text{C}$	$\leq \pm 0.2^\circ\text{C} / ^\circ\text{C}$

EMC immunity influence	$< \pm 0.5\%$ of span
Extended EMC immunity: NAMUR NE 21, A criterion, burst	$< \pm 1\%$ of span

Auxiliary supplies:

Reference voltage	2.5 VDC $\pm 0.5\%$ / 15 mA
2-wire supply (pin 44...42 and 54...52)	28...17.1 VDC / 0...20 mA
Max. wire size	1 x 2.5 mm ² stranded wire
Screw terminal torque	0.5 Nm
Relative humidity	$< 95\%$ RH (non-cond.)
Dimensions (HxWxD)	109 x 23.5 x 130 mm
DIN rail type	DIN 46277
Protection degree	IP20
Weight	225 g

Electrical specifications, temperature input:

TC input:

Type	Min. temperature	Max. temperature	Min. span	Standard
B	+400°C	+1820°C	200°C	IEC584
E	-100°C	+1000°C	50°C	IEC584
J	-100°C	+1200°C	50°C	IEC584
K	-180°C	+1372°C	50°C	IEC584
L	-100°C	+900°C	50°C	DIN 43710
N	-180°C	+1300°C	100°C	IEC584
R	-50°C	+1760°C	200°C	IEC584
S	-50°C	+1760°C	200°C	IEC584
T	-200°C	+400°C	50°C	IEC584
U	-200°C	+600°C	75°C	DIN 43710
W3	0°C	+2300°C	200°C	ASTM E988-90
W5	0°C	+2300°C	200°C	ASTM E988-90
LR	-200°C	+800°C	50°C	GOST 3044-84

Max. offset 50% of selec. max. value

Sensor error current..... Nom. 30 μ A

CJC $\leq \pm 1^\circ\text{C}$

Sensor error detection..... Yes

mV input:

Measurement range..... -150...+150 mV

Min. measurement range..... 5 mV

Max. offset 50% of selec. max. value

Input resistance..... Nom. 10 M Ω

RTD and linear resistance input:

Type	Min. value	Max. value	Min. span	Standard
Pt100	-200°C	+850°C	25°C	IEC 751
Ni100	-60°C	+250°C	25°C	DIN 43760
Lin. R	0 Ω	5000 Ω	30 Ω	-----

Max. offset 50% of selec. max. value

Max. cable resistance per wire..... 10 Ω

Sensor current..... Nom. 0.2 mA

Effect of sensor cable resistance

(3- / 4-wire)..... < 0.002 Ω / Ω

Sensor error detection..... Yes

Electrical specifications, mA / V / mV input:

Current input:

Measurement range.....	0...100 mA
Min. measurement range (span).....	4 mA
Max. offset	50% of selec. max. value
Input resistance:	
Supplied unit.....	Nom. 10 Ω + PTC 10 Ω
Non-supplied unit	RSHUNT = ∞ , VDROP < 6 V

Voltage input:

Measurement range.....	0...250 VDC
Min. measurement range (span).....	5 mVDC
Max. offset	50% of selec. max. value
Input resistance \leq 2.5 VDC.....	Nom. 10 M Ω
$>$ 2.5 VDC.....	Nom. 5 M Ω

Electrical specifications - OUTPUT:

Current output:

Signal range (span).....	0...20 mA
Min. signal range (span).....	10 mA
Max. offset	50% of selec. max. value
Load.....	\leq 600 Ω
Load stability.....	\leq 0.01% of span / 100 Ω
Current limit.....	\leq 28 mA

Voltage output:

Signal range (span).....	0...10 VDC
Min. signal range (span).....	500 mV
Max. offset	50% of selec. max. value
Load.....	\geq 500 k Ω

2-wire 4...20 mA output:

Signal range.....	4...20 mA
Load stability.....	\leq 0.01% of span / 100 Ω
Load resistance.....	\leq (V _{supply} -3.5) / 0.023 A [Ω]
Max. external 2-wire supply	29 VDC
Effect of external 2-wire supply voltage change.....	< 0.005% of span / V

Sensor error detection:

Programmable	0...23 mA
NAMUR NE43 Upscale.....	23 mA
NAMUR NE43 Downscale.....	3.5 mA
No function	Not defined

EEx / I.S. approval (5114B):DEMKO 99ATEX124571  II (1) GD

[EEx ia] IIC

Applicable in Zone 0, 1, 2, 20, 21 or 22

Ex / I.S. data for 5114B, all types:

Terminal 31, 32, and 33

U_m : 250 V**Ex / I.S. data for 5114 B1 (channel 1 for 5114B3):**

Terminal 41, 42, 44 to 43 (51, 52, 54 to 53)

U₀ : 7.5 VDCI₀ : 6.0 mADCP₀ : 11.25 mWL₀ : 200 mHC₀ : 6.0 µF**Ex / I.S. data for 5114 B2 (channel 2 for 5114B3):**

Terminal 44 to 41 (54 to 51)

U₀ : 28 VDCI₀ : 87 mADCP₀ : 0.62 WL₀ : 4.2 mHC₀ : 0.08 µF

Terminal 42, 43 to 41 (52, 53 to 51)

U₀ : 7.5 VDCI₀ : 6.0 mADCP₀ : 11.25 mWL₀ : 200 mHC₀ : 6.0 µF**Marine approval:**

Det Norske Veritas, Ships & Offshore Standard for Certification No. 2.4

Ex / I.S. approval:

ATEX 2014/34/EU DEMKO 99ATEX124571

EAC Ex TR-CU 012/2011 RU C-DK.GB08.V.00410

Observed authority requirements:

EMC 2014/30/EU

RoHS 2011/65/EU

LVD 2014/35/EU

EAC TR-CU 020/2011

Of span = Of the presently selected range

ORDER

Type	Version	Input	Channels
5114	Standard : A	RTD / TC / R / mA / V / mV : -	Single : A
	ATEX Ex : B	RTD / TC / mV / R : 1 mA / V / mV : 2 Channel 1, RTD / TC / mV / R : 3 Channel 2, mA / V / mV	Double : B

Note! For TC inputs with internal CJC, remember to order the CJC connectors type 5910 / 5910 Ex (ch. 1) and 5913 / 5913 Ex (ch. 2).

5114 CONNECTION TO LOOP LINK

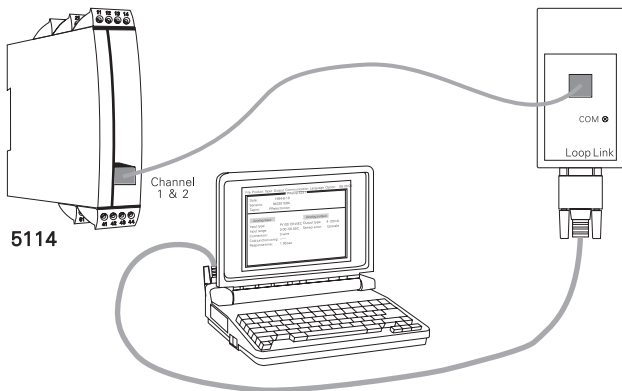

BLOCK DIAGRAM

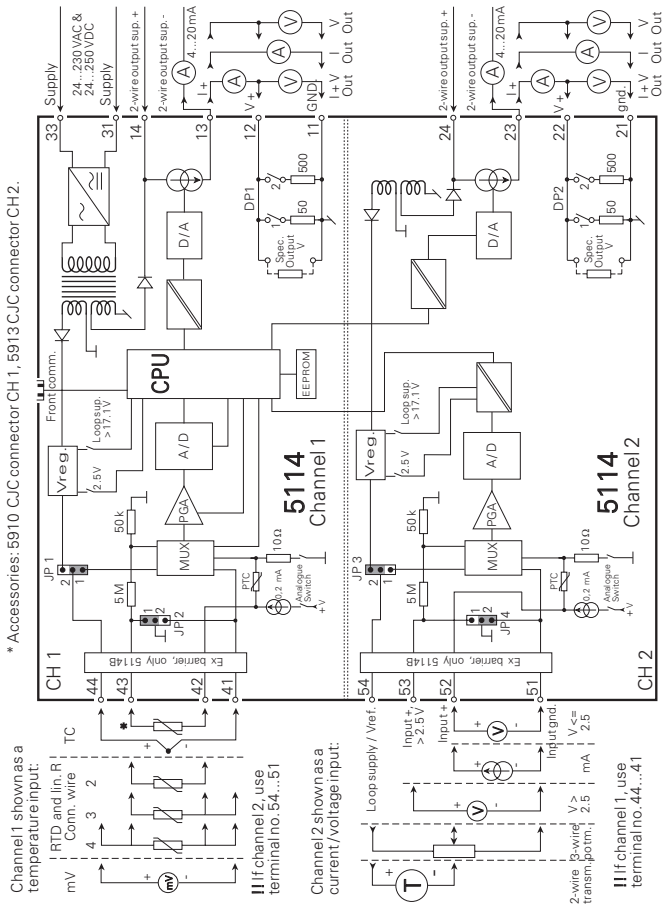

SELECTION OF INPUT TYPE: (5114A)

Input	JP 1	JP 2	JP 3	JP 4
Temperature channel 1	1	1	-	-
Temperature channel 2	-	-	1	1
Current / voltage channel 1	2	2	-	-
Current / voltage channel 2	-	-	2	2



Displays Programmable displays with a wide selection of inputs and outputs for display of temperature, volume and weight, etc. Feature linearization, scaling, and difference measurement functions for programming via PReset software.



Ex interfaces Interfaces for analogue and digital signals as well as HART signals between sensors / I/P converters / frequency signals and control systems in Ex zone 0, 1 & 2 and for some devices in zone 20, 21 & 22.



Isolation Galvanic isolators for analog and digital signals as well as HART signals. A wide product range with both loop-powered and universal isolators featuring linearization, inversion, and scaling of output signals.





























Temperature A wide selection of transmitters for DIN form B mounting and DIN rail devices with analog and digital bus communication ranging from application-specific to universal transmitters.



Multifunctional PC or front programmable devices with universal options for input, output and supply. This range offers a number of advanced features such as process calibration, linearization and auto-diagnosis.



-   www.preelectronics.fr
 sales-fr@preelectronics.com
-   www.preelectronics.de
 sales-de@preelectronics.com
-   www.preelectronics.es
 sales-es@preelectronics.com
-   www.preelectronics.it
 sales-it@preelectronics.com
-   www.preelectronics.se
 sales-se@preelectronics.com
-   www.preelectronics.com
 sales-uk@preelectronics.com
-   www.preelectronics.com
 sales-us@preelectronics.com
-   www.preelectronics.cn
 sales-cn@preelectronics.com
-   www.preelectronics.be
 sales-be@preelectronics.com

Head office

Denmark
PR electronics A/S
Lerbakken 10
DK-8410 Rønne

www.preelectronics.com
sales@preelectronics.dk
tel. +45 86 37 26 77
fax +45 86 37 30 85



QUALITY SYSTEM AND ENVIRONMENTAL MANAGEMENT SYSTEM
DS/EN ISO 9001
DS/EN ISO 14001

